



OM-1324

204 408A

November 2001

Processes



MIG (GMAW) Welding

Flux Cored (FCAW) Welding

Description



Arc Welding Power Source And
Wire Feeder

Millermatic® 135/175 And M-10 Gun

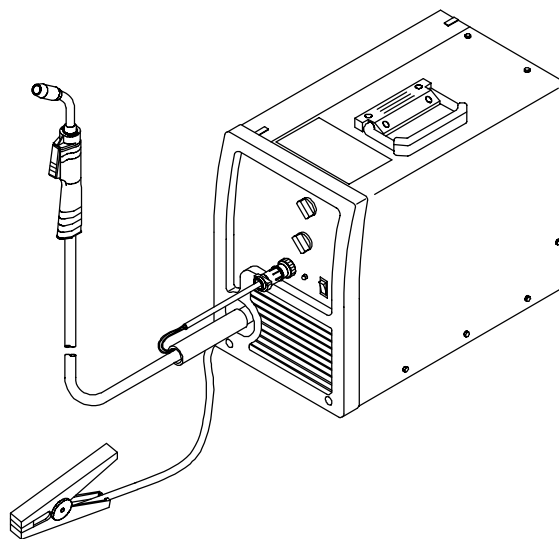

OWNER'S MANUAL



Visit our website at
www.MillerWelds.com

From Miller to You

Thank you and congratulations on choosing Miller. Now you can get the job done and get it done right. We know you don't have time to do it any other way.

That's why when Niels Miller first started building arc welders in 1929, he made sure his products offered long-lasting value and superior quality. Like you, his customers couldn't afford anything less. Miller products had to be more than the best they could be. They had to be the best you could buy.

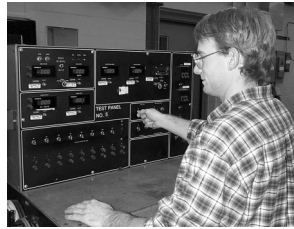

Today, the people that build and sell Miller products continue the tradition. They're just as committed to providing equipment and service that meets the high standards of quality and value established in 1929.

This Owner's Manual is designed to help you get the most out of your Miller products. Please take time to read the Safety precautions. They will help you protect yourself against potential hazards on the worksite.



Miller is the first welding equipment manufacturer in the U.S.A. to be registered to the ISO 9001 Quality System Standard.

We've made installation and operation quick and easy. With Miller you can count on years of reliable service with proper maintenance. And if for some reason the unit needs repair, there's a Troubleshooting section that will help you figure out what the problem is. The parts list will then help you to decide which exact part you may need to fix the problem. Warranty and service information for your particular model are also provided.



Miller Electric manufactures a full line of welders and welding related equipment. For information on other quality Miller products, contact your local Miller distributor to receive the latest full line catalog or individual catalog sheets. **To locate your nearest distributor or service agency call 1-800-4-A-Miller, or visit us at www.MillerWelds.com on the web.**

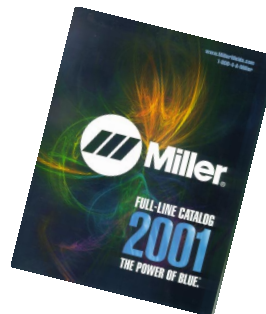

Working as hard as you do – every power source from Miller is backed by the most hassle-free warranty in the business.

Miller offers a *Technical Manual* which provides more detailed service and parts information for your unit. To obtain a *Technical Manual*, contact your local distributor. Your distributor can also supply you with *Welding Process Manuals* such as SMAW, GTAW, GMAW, and GMAW-P.



TABLE OF CONTENTS

WARNING

This product, when used for welding or cutting, produces fumes or gases which contain chemicals known to the State of California to cause birth defects and, in some cases, cancer. (California Health & Safety Code Section 25249.5 et seq.)

The following terms are used interchangeably throughout this manual:
MIG=GMAW

SECTION 1 – SAFETY PRECAUTIONS - READ BEFORE USING	1
1-1. Symbol Usage	1
1-2. Arc Welding Hazards	1
1-3. Additional Symbols For Installation, Operation, And Maintenance	3
1-4. Principal Safety Standards	3
1-5. EMF Information	4
SECTION 1 – CONSIGNES DE SECURITE – LIRE AVANT UTILISATION	5
1-1. Signification des symboles	5
1-2. Dangers relatifs au soudage à l'arc	5
1-3. Dangers supplémentaires en relation avec l'installation, le fonctionnement et la maintenance	7
1-4. Principales normes de sécurité	8
1-5. Information sur les champs électromagnétiques	8
SECTION 2 – SPECIFICATIONS	9
2-1. Specifications	9
2-2. Duty Cycle And Overheating	10
2-3. Volt-Ampere Curves	11
SECTION 3 – INSTALLATION	12
3-1. Installing Welding Gun	12
3-2. Installing Work Clamp	12
3-3. Work Cable Routing Inside Unit	12
3-4. Process/Polarity Table	13
3-5. Changing Polarity	13
3-6. Installing Gas Supply	14
3-7. Selecting A Location And Connecting Input Power For 115 VAC Model	15
3-8. Selecting A Location And Connecting Input Power For 230 VAC Model	16
3-9. Electrical Service Guide For 230 VAC Model	17
3-10. Installing Wire Spool And Adjusting Hub Tension	17
3-11. Threading Welding Wire	18
SECTION 4 – OPERATION	19
4-1. Controls	19
4-2. Weld Parameter Chart For 115 VAC Model	20
4-3. Weld Parameter Chart For 230 VAC Model	22
SECTION 5 – MAINTENANCE & TROUBLESHOOTING	24
5-1. Routine Maintenance	24
5-2. Overload Protection	24
5-3. Drive Motor Protection And Tip Saver/Short Circuit Protection	24
5-4. Changing Drive Roll Or Wire Inlet Guide	25
5-5. Replacing Gun Contact Tip	25
5-6. Cleaning Or Replacing Gun Liner	26
5-7. Replacing Switch And/Or Head Tube	27
5-8. Troubleshooting Table	28
SECTION 6 – ELECTRICAL DIAGRAM	29
SECTION 7 – MIG WELDING (GMAW) GUIDELINES	31
7-1. Typical MIG Process Connections	31
7-2. Typical MIG Process Control Settings	32
7-3. Holding And Positioning Welding Gun	33
7-4. Conditions That Affect Weld Bead Shape	34
7-5. Gun Movement During Welding	35
7-6. Poor Weld Bead Characteristics	35
7-7. Good Weld Bead Characteristics	35
7-8. Troubleshooting – Excessive Spatter	36
7-9. Troubleshooting – Porosity	36
7-10. Troubleshooting – Excessive Penetration	37
7-11. Troubleshooting – Lack Of Penetration	37
7-12. Troubleshooting – Incomplete Fusion	37
7-13. Troubleshooting – Burn-Through	38
7-14. Troubleshooting – Waviness Of Bead	38
7-15. Troubleshooting – Distortion	38
7-16. Common MIG Shielding Gases	39
SECTION 8 – PARTS LIST	40
WARRANTY	

SECTION 1 – SAFETY PRECAUTIONS - READ BEFORE USING

som_nd_4/98

1-1. Symbol Usage



Means Warning! Watch Out! There are possible hazards with this procedure! The possible hazards are shown in the adjoining symbols.

▲ Marks a special safety message.

☞ Means "Note"; not safety related.



This group of symbols means Warning! Watch Out! possible ELECTRIC SHOCK, MOVING PARTS, and HOT PARTS hazards. Consult symbols and related instructions below for necessary actions to avoid the hazards.

1-2. Arc Welding Hazards

▲ The symbols shown below are used throughout this manual to call attention to and identify possible hazards. When you see the symbol, watch out, and follow the related instructions to avoid the hazard. The safety information given below is only a summary of the more complete safety information found in the Safety Standards listed in Section 1-4. Read and follow all Safety Standards.

▲ Only qualified persons should install, operate, maintain, and repair this unit.

▲ During operation, keep everybody, especially children, away.



ELECTRIC SHOCK can kill.

Touching live electrical parts can cause fatal shocks or severe burns. The electrode and work circuit is electrically live whenever the output is on. The input power circuit and machine internal circuits are also

live when power is on. In semiautomatic or automatic wire welding, the wire, wire reel, drive roll housing, and all metal parts touching the welding wire are electrically live. Incorrectly installed or improperly grounded equipment is a hazard.

- Do not touch live electrical parts.
- Wear dry, hole-free insulating gloves and body protection.
- Insulate yourself from work and ground using dry insulating mats or covers big enough to prevent any physical contact with the work or ground.
- Do not use AC output in damp areas, if movement is confined, or if there is a danger of falling.
- Use AC output ONLY if required for the welding process.
- If AC output is required, use remote output control if present on unit.
- Disconnect input power or stop engine before installing or servicing this equipment. Lockout/tagout input power according to OSHA 29 CFR 1910.147 (see Safety Standards).
- Properly install and ground this equipment according to its Owner's Manual and national, state, and local codes.
- Always verify the supply ground – check and be sure that input power cord ground wire is properly connected to ground terminal in disconnect box or that cord plug is connected to a properly grounded receptacle outlet.
- When making input connections, attach proper grounding conductor first – double-check connections.
- Frequently inspect input power cord for damage or bare wiring – replace cord immediately if damaged – bare wiring can kill.
- Turn off all equipment when not in use.
- Do not use worn, damaged, undersized, or poorly spliced cables.
- Do not drape cables over your body.

- If earth grounding of the workpiece is required, ground it directly with a separate cable.
- Do not touch electrode if you are in contact with the work, ground, or another electrode from a different machine.
- Use only well-maintained equipment. Repair or replace damaged parts at once. Maintain unit according to manual.
- Wear a safety harness if working above floor level.
- Keep all panels and covers securely in place.
- Clamp work cable with good metal-to-metal contact to workpiece or worktable as near the weld as practical.
- Insulate work clamp when not connected to workpiece to prevent contact with any metal object.
- Do not connect more than one electrode or work cable to any single weld output terminal.

SIGNIFICANT DC VOLTAGE exists after removal of input power on inverters.

- Turn Off inverter, disconnect input power, and discharge input capacitors according to instructions in Maintenance Section before touching any parts.

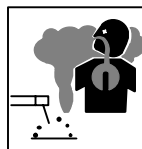

FUMES AND GASES can be hazardous.

Welding produces fumes and gases. Breathing these fumes and gases can be hazardous to your health.

- Keep your head out of the fumes. Do not breathe the fumes.
- If inside, ventilate the area and/or use exhaust at the arc to remove welding fumes and gases.
- If ventilation is poor, use an approved air-supplied respirator.
- Read the Material Safety Data Sheets (MSDSs) and the manufacturer's instructions for metals, consumables, coatings, cleaners, and degreasers.
- Work in a confined space only if it is well ventilated, or while wearing an air-supplied respirator. Always have a trained watch-person nearby. Welding fumes and gases can displace air and lower the oxygen level causing injury or death. Be sure the breathing air is safe.
- Do not weld in locations near degreasing, cleaning, or spraying operations. The heat and rays of the arc can react with vapors to form highly toxic and irritating gases.
- Do not weld on coated metals, such as galvanized, lead, or cadmium plated steel, unless the coating is removed from the weld area, the area is well ventilated, and if necessary, while wearing an air-supplied respirator. The coatings and any metals containing these elements can give off toxic fumes if welded.



ARC RAYS can burn eyes and skin.

Arc rays from the welding process produce intense visible and invisible (ultraviolet and infrared) rays that can burn eyes and skin. Sparks fly off from the weld.

- Wear a welding helmet fitted with a proper shade of filter to protect your face and eyes when welding or watching (see ANSI Z49.1 and Z87.1 listed in Safety Standards).
- Wear approved safety glasses with side shields under your helmet.
- Use protective screens or barriers to protect others from flash and glare; warn others not to watch the arc.
- Wear protective clothing made from durable, flame-resistant material (leather and wool) and foot protection.



WELDING can cause fire or explosion.

Welding on closed containers, such as tanks, drums, or pipes, can cause them to blow up. Sparks can fly off from the welding arc. The flying sparks, hot workpiece, and hot equipment can cause fires and burns. Accidental contact of electrode to metal objects can cause sparks, explosion, overheating, or fire. Check and be sure the area is safe before doing any welding.

- Protect yourself and others from flying sparks and hot metal.
- Do not weld where flying sparks can strike flammable material.
- Remove all flammables within 35 ft (10.7 m) of the welding arc. If this is not possible, tightly cover them with approved covers.
- Be alert that welding sparks and hot materials from welding can easily go through small cracks and openings to adjacent areas.
- Watch for fire, and keep a fire extinguisher nearby.
- Be aware that welding on a ceiling, floor, bulkhead, or partition can cause fire on the hidden side.
- Do not weld on closed containers such as tanks, drums, or pipes, unless they are properly prepared according to AWS F4.1 (see Safety Standards).
- Connect work cable to the work as close to the welding area as practical to prevent welding current from traveling long, possibly unknown paths and causing electric shock and fire hazards.
- Do not use welder to thaw frozen pipes.
- Remove stick electrode from holder or cut off welding wire at contact tip when not in use.
- Wear oil-free protective garments such as leather gloves, heavy shirt, cuffless trousers, high shoes, and a cap.
- Remove any combustibles, such as a butane lighter or matches, from your person before doing any welding.

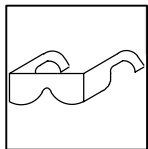

FLYING METAL can injure eyes.

- Welding, chipping, wire brushing, and grinding cause sparks and flying metal. As welds cool, they can throw off slag.
- Wear approved safety glasses with side shields even under your welding helmet.



BUILDUP OF GAS can injure or kill.

- Shut off shielding gas supply when not in use.
- Always ventilate confined spaces or use approved air-supplied respirator.



HOT PARTS can cause severe burns.

- Do not touch hot parts bare handed.
- Allow cooling period before working on gun or torch.

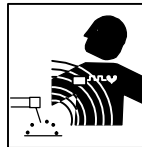

MAGNETIC FIELDS can affect pacemakers.

- Pacemaker wearers keep away.
- Wearers should consult their doctor before going near arc welding, gouging, or spot welding operations.

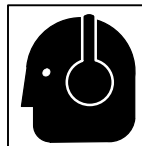

NOISE can damage hearing.

Noise from some processes or equipment can damage hearing.

- Wear approved ear protection if noise level is high.

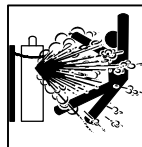

CYLINDERS can explode if damaged.

Shielding gas cylinders contain gas under high pressure. If damaged, a cylinder can explode. Since gas cylinders are normally part of the welding process, be sure to treat them carefully.

- Protect compressed gas cylinders from excessive heat, mechanical shocks, slag, open flames, sparks, and arcs.
- Install cylinders in an upright position by securing to a stationary support or cylinder rack to prevent falling or tipping.
- Keep cylinders away from any welding or other electrical circuits.
- Never drape a welding torch over a gas cylinder.
- Never allow a welding electrode to touch any cylinder.
- Never weld on a pressurized cylinder – explosion will result.
- Use only correct shielding gas cylinders, regulators, hoses, and fittings designed for the specific application; maintain them and associated parts in good condition.
- Turn face away from valve outlet when opening cylinder valve.
- Keep protective cap in place over valve except when cylinder is in use or connected for use.
- Read and follow instructions on compressed gas cylinders, associated equipment, and CGA publication P-1 listed in Safety Standards.

1-3. Additional Symbols For Installation, Operation, And Maintenance



FIRE OR EXPLOSION hazard.

- Do not install or place unit on, over, or near combustible surfaces.
- Do not install unit near flammables.
- Do not overload building wiring – be sure power supply system is properly sized, rated, and protected to handle this unit.



MOVING PARTS can cause injury.

- Keep away from moving parts such as fans.
- Keep all doors, panels, covers, and guards closed and securely in place.



FALLING UNIT can cause injury.

- Use lifting eye to lift unit only, NOT running gear, gas cylinders, or any other accessories.
- Use equipment of adequate capacity to lift and support unit.
- If using lift forks to move unit, be sure forks are long enough to extend beyond opposite side of unit.

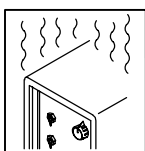

OVERUSE can cause OVERHEATING

- Allow cooling period; follow rated duty cycle.
- Reduce current or reduce duty cycle before starting to weld again.
- Do not block or filter airflow to unit.

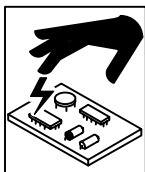

STATIC (ESD) can damage PC boards.

- Put on grounded wrist strap BEFORE handling boards or parts.
- Use proper static-proof bags and boxes to store, move, or ship PC boards.



MOVING PARTS can cause injury.

- Keep away from moving parts.
- Keep away from pinch points such as drive rolls.



WELDING WIRE can cause injury.

- Do not press gun trigger until instructed to do so.
- Do not point gun toward any part of the body, other people, or any metal when threading welding wire.

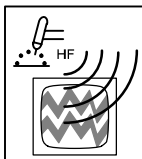

H.F. RADIATION can cause interference.

- High-frequency (H.F.) can interfere with radio navigation, safety services, computers, and communications equipment.
- Have only qualified persons familiar with electronic equipment perform this installation.
- The user is responsible for having a qualified electrician promptly correct any interference problem resulting from the installation.
- If notified by the FCC about interference, stop using the equipment at once.
- Have the installation regularly checked and maintained.
- Keep high-frequency source doors and panels tightly shut, keep spark gaps at correct setting, and use grounding and shielding to minimize the possibility of interference.

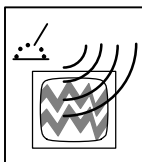

ARC WELDING can cause interference.

- Electromagnetic energy can interfere with sensitive electronic equipment such as computers and computer-driven equipment such as robots.
- Be sure all equipment in the welding area is electromagnetically compatible.
- To reduce possible interference, keep weld cables as short as possible, close together, and down low, such as on the floor.
- Locate welding operation 100 meters from any sensitive electronic equipment.
- Be sure this welding machine is installed and grounded according to this manual.
- If interference still occurs, the user must take extra measures such as moving the welding machine, using shielded cables, using line filters, or shielding the work area.

1-4. Principal Safety Standards

Safety in Welding and Cutting, ANSI Standard Z49.1, from American Welding Society, 550 N.W. LeJeune Rd, Miami FL 33126

Safety and Health Standards, OSHA 29 CFR 1910, from Superintendent of Documents, U.S. Government Printing Office, Washington, D.C. 20402.

Recommended Safe Practices for the Preparation for Welding and Cutting of Containers That Have Held Hazardous Substances, American Welding Society Standard AWS F4.1, from American Welding Society, 550 N.W. LeJeune Rd, Miami, FL 33126

National Electrical Code, NFPA Standard 70, from National Fire Protection Association, Batterymarch Park, Quincy, MA 02269.

Safe Handling of Compressed Gases in Cylinders, CGA Pamphlet P-1, from Compressed Gas Association, 1235 Jefferson Davis Highway, Suite 501, Arlington, VA 22202.

Code for Safety in Welding and Cutting, CSA Standard W117.2, from Canadian Standards Association, Standards Sales, 178 Rexdale Boulevard, Rexdale, Ontario, Canada M9W 1R3.

Safe Practices For Occupation And Educational Eye And Face Protection, ANSI Standard Z87.1, from American National Standards Institute, 1430 Broadway, New York, NY 10018.

Cutting And Welding Processes, NFPA Standard 51B, from National Fire Protection Association, Batterymarch Park, Quincy, MA 02269.

1-5. EMF Information

Considerations About Welding And The Effects Of Low Frequency Electric And Magnetic Fields

Welding current, as it flows through welding cables, will cause electromagnetic fields. There has been and still is some concern about such fields. However, after examining more than 500 studies spanning 17 years of research, a special blue ribbon committee of the National Research Council concluded that: "The body of evidence, in the committee's judgment, has not demonstrated that exposure to power-frequency electric and magnetic fields is a human-health hazard." However, studies are still going forth and evidence continues to be examined. Until the final conclusions of the research are reached, you may wish to minimize your exposure to electromagnetic fields when welding or cutting.

To reduce magnetic fields in the workplace, use the following procedures:

1. Keep cables close together by twisting or taping them.
2. Arrange cables to one side and away from the operator.
3. Do not coil or drape cables around your body.
4. Keep welding power source and cables as far away from operator as practical.
5. Connect work clamp to workpiece as close to the weld as possible.

About Pacemakers:

Pacemaker wearers consult your doctor first. If cleared by your doctor, then following the above procedures is recommended.

SECTION 1 – CONSIGNES DE SECURITE – LIRE AVANT UTILISATION

som_nd_fre 4/98

1-1. Signification des symboles



Signifie Mise en garde ! Soyez vigilant ! Cette procédure présente des risques de danger ! Ceux-ci sont identifiés par des symboles adjacents aux directives.

▲ Identifie un message de sécurité particulier.

Signifie NOTA ; n'est pas relatif à la sécurité.



Ce groupe de symboles signifie Mise en garde ! Soyez vigilant ! Il y a des risques de danger reliés aux CHOCS ÉLECTRIQUES, aux PIÈCES EN MOUVEMENT et aux PIÈCES CHAUDES. Reportez-vous aux symboles et aux directives ci-dessous afin de connaître les mesures à prendre pour éviter tout danger.

1-2. Dangers relatifs au soudage à l'arc

▲ Les symboles présentés ci-après sont utilisés tout au long du présent manuel pour attirer votre attention et identifier les risques de danger. Lorsque vous voyez un symbole, soyez vigilant et suivez les directives mentionnées afin d'éviter tout danger. Les consignes de sécurité présentées ci-après ne font que résumer l'information contenue dans les normes de sécurité énumérées à la section 1-4. Veuillez lire et respecter toutes ces normes de sécurité.

▲ L'installation, l'utilisation, l'entretien et les réparations ne doivent être confiés qu'à des personnes qualifiées.

▲ Au cours de l'utilisation, tenir toute personne à l'écart et plus particulièrement les enfants.



UN CHOC ÉLECTRIQUE peut tuer.

Un simple contact avec des pièces électriques peut provoquer une électrocution ou des blessures graves. L'électrode et le circuit de soudage sont sous tension dès que l'appareil est sur ON. Le circuit d'entrée et les circuits internes de l'appareil sont également sous tension à ce moment-là. En soudage semi-automatique ou automatique, le fil, le dévidoir, le logement des galets d'entraînement et les pièces métalliques en contact avec le fil de soudage sont sous tension. Des matériels mal installés ou mal mis à la terre présentent un danger.

- Ne jamais toucher les pièces électriques sous tension.
- Porter des gants et des vêtements de protection secs ne comportant pas de trous.
- S'isoler de la pièce et de la terre au moyen de tapis ou d'autres moyens isolants suffisamment grands pour empêcher le contact physique éventuel avec la pièce ou la terre.
- Ne pas se servir de source électrique à courant électrique dans les zones humides, dans les endroits confinés ou là où on risque de tomber.
- Se servir d'une source électrique à courant électrique UNIQUEMENT si le procédé de soudage le demande.
- Si l'utilisation d'une source électrique à courant électrique s'avère nécessaire, se servir de la fonction de télécommande si l'appareil en est équipé.
- Couper l'alimentation ou arrêter le moteur avant de procéder à l'installation, à la réparation ou à l'entretien de l'appareil. Déverrouiller l'alimentation selon la norme OSHA 29 CFR 1910.147 (voir normes de sécurité).
- Installer et mettre à la terre correctement cet appareil conformément à son manuel d'utilisation et aux codes nationaux, provinciaux et municipaux.
- Toujours vérifier la terre du cordon d'alimentation – Vérifier et s'assurer que le fil de terre du cordon d'alimentation est bien raccordé à la borne de terre du sectionneur ou que la fiche du cordon est raccordée à une prise correctement mise à la terre.
- En effectuant les raccordements d'entrée fixer d'abord le conducteur de mise à la terre approprié et contre-vérifier les connexions.
- Vérifier fréquemment le cordon d'alimentation pour voir s'il n'est pas endommagé ou dénudé – remplacer le cordon immédiatement s'il est endommagé – un câble dénudé peut provoquer une électrocution.
- Mettre l'appareil hors tension quand on ne l'utilise pas.
- Ne pas utiliser des câbles usés, endommagés, de grosseur insuffisante ou mal épissés.
- Ne pas enrouler les câbles autour du corps.
- Si la pièce soudée doit être mise à la terre, le faire directement avec un câble distinct.
- Ne pas toucher l'électrode quand on est en contact avec la pièce, la terre ou une électrode provenant d'une autre machine.

- N'utiliser qu'un matériel en bon état. Réparer ou remplacer sur-le-champ les pièces endommagées. Entretien l'appareil conformément à ce manuel.
- Porter un harnais de sécurité quand on travaille en hauteur.
- Maintenir solidement en place tous les panneaux et capots.
- Fixer le câble de retour de façon à obtenir un bon contact métal-métal avec la pièce à souder ou la table de travail, le plus près possible de la soudure.
- Isoler la pince de masse quand pas mis à la pièce pour éviter le contact avec tout objet métallique.

Il y a DU COURANT CONTINU IMPORTANT dans les convertisseurs après la suppression de l'alimentation électrique.

- Arrêter les convertisseurs, débrancher le courant électrique, et décharger les condensateurs d'alimentation selon les instructions indiquées dans la partie entretien avant de toucher les pièces.

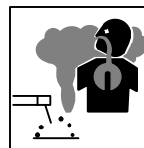

LES FUMÉES ET LES GAZ peuvent être dangereux.

Le soudage génère des fumées et des gaz. Leur inhalation peut être dangereux pour votre santé.

- Eloigner votre tête des fumées. Ne pas respirer les fumées.
- A l'intérieur, ventiler la zone et/ou utiliser un échappement au niveau de l'arc pour l'évacuation des fumées et des gaz de soudage.
- Si la ventilation est insuffisante, utiliser un respirateur à alimentation d'air homologué.
- Lire les spécifications de sécurité des matériaux (MSDSs) et les instructions du fabricant concernant les métaux, les consommables, les revêtements, les nettoyants et les dégraissants.
- Travailler dans un espace fermé seulement s'il est bien ventilé ou en portant un respirateur à alimentation d'air. Demander toujours à un surveillant dûment formé de se tenir à proximité. Des fumées et des gaz de soudage peuvent déplacer l'air et abaisser le niveau d'oxygène provoquant des blessures ou des accidents mortels. S'assurer que l'air de respiration ne présente aucun danger.
- Ne pas souder dans des endroits situés à proximité d'opérations de dégraissage, de nettoyage ou de pulvérisation. La chaleur et les rayons de l'arc peuvent réagir en présence de vapeurs et former des gaz hautement toxiques et irritants.
- Ne pas souder des métaux munis d'un revêtement, tels que l'acier galvanisé, plaqué en plomb ou au cadmium à moins que le revêtement n'ait été enlevé dans la zone de soudure, que l'endroit soit bien ventilé, et si nécessaire, en portant un respirateur à alimentation d'air. Les revêtements et tous les métaux renfermant ces éléments peuvent dégager des fumées toxiques en cas de soudage.



LES RAYONS DE L'ARC peuvent provoquer des brûlures dans les yeux et sur la peau.

Le rayonnement de l'arc du procédé de soudage génère des rayons visibles et invisibles intenses (ultraviolets et infrarouges) susceptibles de provoquer des brûlures dans les yeux et sur la peau. Des étincelles sont projetées pendant le soudage.

- Porter un casque de soudage muni d'un écran de filtre approprié pour protéger votre visage et vos yeux pendant le soudage ou pour regarder (voir ANSI Z49.1 et Z87.1 énuméré dans les normes de sécurité).
- Porter des protections approuvés pour les oreilles si le niveau sonore est trop élevé.
- Utiliser des écrans ou des barrières pour protéger des tiers de l'éclair et de l'éblouissement; demander aux autres personnes de ne pas regarder l'arc.
- Porter des vêtements de protection constitué dans une matière durable, résistant au feu (cuir ou laine) et une protection des pieds.



LE SOUDAGE peut provoquer un incendie ou une explosion.

Le soudage effectué sur des conteneurs fermés tels que des réservoirs, tambours ou des conduites peut provoquer leur éclatement. Des étincelles peuvent être projetées de l'arc de soudure. La projection d'étincelles, des pièces chaudes et des équipements chauds peut provoquer des incendies et des brûlures. Le contact accidentel de l'électrode avec des objets métalliques peut provoquer des étincelles, une explosion, un surchauffement ou un incendie. Avant de commencer le soudage, vérifier et s'assurer que l'endroit ne présente pas de danger.

- Se protéger et d'autres personnes de la projection d'étincelles et de métal chaud.
- Ne pas souder dans un endroit là où des étincelles peuvent tomber sur des substances inflammables.
- Déplacer toutes les substances inflammables à une distance de 10,7 m de l'arc de soudage. En cas d'impossibilité les recouvrir soigneusement avec des protections homologués.
- Des étincelles et des matériaux chauds du soudage peuvent facilement passer dans d'autres zones en traversant de petites fissures et des ouvertures.
- Surveiller tout déclenchement d'incendie et tenir un extincteur à proximité.
- Le soudage effectué sur un plafond, plancher, paroi ou séparation peut déclencher un incendie de l'autre côté.
- Ne pas effectuer le soudage sur des conteneurs fermés tels que des réservoirs, tambours, ou conduites, à moins qu'ils n'aient été préparés correctement conformément à AWS F4.1 (voir les normes de sécurité).
- Brancher le câble sur la pièce le plus près possible de la zone de soudage pour éviter le transport du courant sur une longue distance par des chemins inconnus éventuels en provoquant des risques d'électrocution et d'incendie.
- Ne pas utiliser le poste de soudage pour décongeler des conduites gelées.
- En cas de non utilisation, enlever la baguette d'électrode du porte-électrode ou couper le fil à la pointe de contact.
- Porter des vêtements de protection dépourvus d'huile tels que des gants en cuir, une chemise en matériau lourd, des pantalons sans revers, des chaussures hautes et un couvre chef.
- Avant de souder, retirer toute substance combustible de vos poches telles qu'un allumeur au butane ou des allumettes.

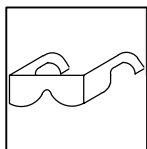

DES PARTICULES VOLANTES peuvent blesser les yeux.

- Le soudage, l'écaillage, le passage de la pièce à la brosse en fil de fer, et le meulage génèrent des étincelles et des particules métalliques volantes. Pendant la période de refroidissement des soudures, elles risquent de projeter du laitier.
- Porter des lunettes de sécurité avec écrans latéraux ou un écran facial.



LES ACCUMULATIONS DE GAZ risquent de provoquer des blessures ou même la mort.

- Fermer l'alimentation du gaz protecteur en cas de non utilisation.
- Veiller toujours à bien aérer les espaces confinés ou se servir d'un respirateur d'adduction d'air homologué.



DES PIÈCES CHAUDES peuvent provoquer des brûlures graves.

- Ne pas toucher des parties chaudes à mains nues
- Prévoir une période de refroidissement avant d'utiliser le pistolet ou la torche.

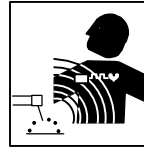

LES CHAMPS MAGNÉTIQUES peuvent affecter les stimulateurs cardiaques.

- Porteurs de stimulateur cardiaque, restez à distance.
- Les porteurs d'un stimulateur cardiaque doivent d'abord consulter leur médecin avant de s'approcher des opérations de soudage à l'arc, de gougeage ou de soudage par points.

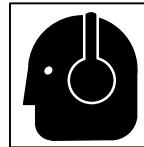

LE BRUIT peut affecter l'ouïe.

Le bruit des processus et des équipements peut affecter l'ouïe.

- Porter des protections approuvés pour les oreilles si le niveau sonore est trop élevé.

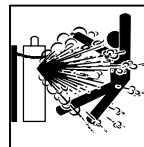

Si des BOUTEILLES sont endommagées, elles pourront exploser.

Des bouteilles de gaz protecteur contiennent du gaz sous haute pression. Si une bouteille est endommagée, elle peut exploser. Du fait que les bouteilles de gaz font normalement partie du procédé de soudage, les manipuler avec précaution.

- Protéger les bouteilles de gaz comprimé d'une chaleur excessive, des chocs mécaniques, du laitier, des flammes ouvertes, des étincelles et des arcs.
- Placer les bouteilles debout en les fixant dans un support stationnaire ou dans un porte-bouteilles pour les empêcher de tomber ou de se renverser.
- Tenir les bouteilles éloignées des circuits de soudage ou autres circuits électriques.
- Ne jamais placer une torche de soudage sur une bouteille à gaz.
- Une électrode de soudage ne doit jamais entrer en contact avec une bouteille.
- Ne jamais souder une bouteille pressurisée – risque d'explosion.
- Utiliser seulement des bouteilles de gaz protecteur, régulateurs, tuyaux et raccords convenables pour cette application spécifique; les maintenir ainsi que les éléments associés en bon état.
- Ne pas tenir la tête en face de la sortie en ouvrant la soupape de la bouteille.
- Maintenir le chapeau de protection sur la soupape, sauf en cas d'utilisation ou de branchement de la bouteille.
- Lire et suivre les instructions concernant les bouteilles de gaz comprimé, les équipements associés et les publications P-1 CGA énumérées dans les normes de sécurité.

1-3. Dangers supplémentaires en relation avec l'installation, le fonctionnement et la maintenance



Risque D'INCENDIE OU D'EXPLOSION.

- Ne pas placer l'appareil sur, au-dessus ou à proximité de surfaces inflammables.
- Ne pas installer l'appareil à proximité de produits inflammables
- Ne pas surcharger l'installation électrique – s'assurer que l'alimentation est correctement dimensionnée et protégée avant de mettre l'appareil en service.



LA CHUTE DE L'APPAREIL peut blesser.

- Utiliser l'anneau de levage uniquement pour soulever l'appareil, NON PAS les chariot, les bouteilles de gaz ou tout autre accessoire.
- Utiliser un engin d'une capacité appropriée pour soulever l'appareil.
- En utilisant des fourches de levage pour déplacer l'unité, s'assurer que les fourches sont suffisamment longues pour dépasser du côté opposé de l'appareil.

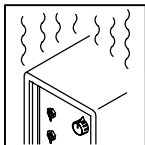

L'EMPLOI EXCESSIF peut SURCHAUFFER L'ÉQUIPEMENT.

- Prévoir une période de refroidissement, respecter le cycle opératoire nominal.
- Réduire le courant ou le cycle opératoire avant de recommencer le soudage.
- Ne pas obstruer les passages d'air du poste.

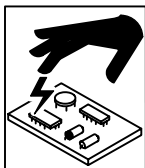

LES CHARGES ÉLECTROSTATIQUES peuvent endommager les circuits imprimés.

- Établir la connexion avec la barrette de terre avant de manipuler des cartes ou des pièces.
- Utiliser des pochettes et des boîtes antistatiques pour stocker, déplacer ou expédier des cartes de circuits imprimés.

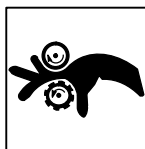

DES ORGANES MOBILES peuvent provoquer des blessures.

- Ne pas s'approcher des organes mobiles.
- Ne pas s'approcher des points de coincement tels que des rouleaux de commande.



LES FILS DE SOUDAGE peuvent provoquer des blessures.

- Ne pas appuyer sur la gachette avant d'en avoir reçu l'instruction.
- Ne pas diriger le pistolet vers soi, d'autres personnes ou toute pièce mécanique en engageant le fil de soudage.



DES ORGANES MOBILES peuvent provoquer des blessures.

- Rester à l'écart des organes mobiles comme le ventilateur.
- Maintenir fermés et fixement en place les portes, panneaux, recouvrements et dispositifs de protection.

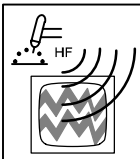

LE RAYONNEMENT HAUTE FRÉQUENCE (H.F.) risque de provoquer des interférences.

- Le rayonnement haute fréquence peut provoquer des interférences avec les équipements de radio-navigation et de communication, les services de sécurité et les ordinateurs.
- Demander seulement à des personnes qualifiées familiarisées avec des équipements électroniques de faire fonctionner l'installation.
- L'utilisateur est tenu de faire corriger rapidement par un électricien qualifié les interférences résultant de l'installation.
- Si le FCC signale des interférences, arrêter immédiatement l'appareil.
- Effectuer régulièrement le contrôle et l'entretien de l'installation.
- Maintenir soigneusement fermés les portes et les panneaux des sources de haute fréquence, maintenir les éclateurs à une distance correcte et utiliser une terre et un blindage pour réduire les interférences éventuelles.

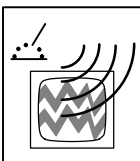

LE SOUDAGE À L'ARC risque de provoquer des interférences.

- L'énergie électromagnétique risque de provoquer des interférences pour l'équipement électronique sensible tel que les ordinateurs et l'équipement commandé par ordinateur tel que les robots.
- Veiller à ce que tout l'équipement de la zone de soudage soit compatible électromagnétiquement.
- Pour réduire la possibilité d'interférence, maintenir les câbles de soudage aussi courts que possible, les grouper, et les poser aussi bas que possible (ex. par terre).
- Veiller à souder à une distance de 100 mètres de tout équipement électronique sensible.
- Veiller à ce que ce poste de soudage soit posé et mis à la terre conformément à ce mode d'emploi.
- En cas d'interférences après avoir pris les mesures précédentes, il incombe à l'utilisateur de prendre des mesures supplémentaires telles que le déplacement du poste, l'utilisation de câbles blindés, l'utilisation de filtres de ligne ou la pose de protecteurs dans la zone de travail.



LES CHAMPS MAGNÉTIQUES peuvent affecter les stimulateurs cardiaques.

- Porteurs de stimulateur cardiaque, restez à distance.
- Les porteurs d'un stimulateur cardiaque doivent d'abord consulter leur médecin avant de s'approcher des opérations de soudage à l'arc, de gougeage ou de soudage par points.

1-4. Principales normes de sécurité

Safety in Welding and Cutting, norme ANSI Z49.1, de l'American Welding Society, 550 N.W. Lejeune Rd, Miami FL 33126

Safety and Health Standards, OSHA 29 CFR 1910, du Superintendent of Documents, U.S. Government Printing Office, Washington, D.C. 20402.

Recommended Safe Practice for the Preparation for Welding and Cutting of Containers That Have Held Hazardous Substances, norme AWS F4.1, de l'American Welding Society, 550 N.W. Lejeune Rd, Miami FL 33126

National Electrical Code, NFPA Standard 70, de la National Fire Protection Association, Batterymarch Park, Quincy, MA 02269.

Safe Handling of Compressed Gases in Cylinders, CGA Pamphlet P-1, de la Compressed Gas Association, 1235 Jefferson Davis Highway, Suite 501, Arlington, VA 22202.

Règles de sécurité en soudage, coupage et procédés connexes, norme CSA W117.2, de l'Association canadienne de normalisation, vente de normes, 178 Rexdale Boulevard, Rexdale (Ontario) Canada M9W 1R3.

Safe Practices For Occupation And Educational Eye And Face Protection, norme ANSI Z87.1, de l'American National Standards Institute, 1430 Broadway, New York, NY 10018.

Cutting and Welding Processes, norme NFPA 51B, de la National Fire Protection Association, Batterymarch Park, Quincy, MA 02269.

1-5. Information sur les champs électromagnétiques

Données sur le soudage électrique et sur les effets, pour l'organisme, des champs magnétiques basse fréquence

Le courant de soudage, pendant son passage dans les câbles de soudage, causera des champs électromagnétiques. Il y a eu et il y a encore un certain souci à propos de tels champs. Cependant, après avoir examiné plus de 500 études qui ont été faites pendant une période de recherche de 17 ans, un comité spécial ruban bleu du National Research Council a conclu: "L'accumulation de preuves, suivant le jugement du comité, n'a pas démontré que l'exposition aux champs magnétiques et champs électriques à haute fréquence représente un risque à la santé humaine". Toutefois, des études sont toujours en cours et les preuves continuent à être examinées. En attendant que les conclusions finales de la recherche soient établies, il vous serait souhaitable de réduire votre exposition aux champs électromagnétiques pendant le soudage ou le coupage.

Afin de réduire les champs électromagnétiques dans l'environnement de travail, respecter les consignes suivantes :

- 1 Garder les câbles ensemble en les torsadant ou en les attachant avec du ruban adhésif.
- 2 Mettre tous les câbles du côté opposé de l'opérateur.
- 3 Ne pas courber pas et ne pas entourer pas les câbles autour de votre corps.
- 4 Garder le poste de soudage et les câbles le plus loin possible de vous.
- 5 Relier la pince de masse le plus près possible de la zone de soudure.

Consignes relatives aux stimulateurs cardiaques :

Les personnes qui portent un stimulateur cardiaque doivent avant tout consulter leur docteur. Si vous êtes déclaré apte par votre docteur, il est alors recommandé de respecter les consignes ci-dessus.

SECTION 2 – SPECIFICATIONS

2-1. Specifications

A. 115 VAC Model

Rated Welding Output	Amperage Range		Maximum Open-Circuit Voltage DC	Amperes Input at Rated Load Output 115 V, 60 Hz, Single-Phase	KVA	KW	Weight W/ Gun	Overall Dimensions
90 A @ 18 Volts DC, 20% Duty Cycle 63 A @ 21 Volts DC, 20% Duty Cycle*	30 – 135		28	20 15*	2.88 2.20*	2.40 1.77*	60 lb (27 kg)	Length: 17-1/2 in (444 mm) Width: 10-5/8 in (273 mm) Height: 15-3/4 in (400 mm)
Wire Type And Dia	Solid	Stainless	Flux Cored	Wire Feed Speed Range				
	.023 - .035 in (0.6 - 0.9 mm)	.023 - .030 in (0.6 - 0.8 mm)	.030 - .045 in (0.8 - 1.1 mm)	170 – 850 IPM (4.3 – 21.6 m/min) At No Load 75 – 750 IPM (1.9 – 19.1 m/min) Feeding Wire				
* CSA Rating								

B. 230 VAC Model

Rated Welding Output	Amperage Range	Maximum Open-Circuit Voltage DC	Amperes Input at Rated Load Output 230 V, 50/60 Hz, Single-Phase	KVA	KW	Weight W/ Gun	Overall Dimensions
130 A @ 20 Volts DC, 30% Duty Cycle At 60 Hz Input	30 – 175	30	19.5	4.60	3.75	73 lb (33.0 kg)	Length: 17-1/2 in (444 mm) Width: 10-5/8 in (273 mm) Height: 15-3/4 in (400 mm)
Wire Type And Dia	Solid/ Stainless	Flux Cored	Wire Feed Speed Range				
	.023 – .035 in (0.6 – 0.9 mm)	.030 – .045 in (0.8 – 1.2 mm)	150 – 900 IPM (3.8 – 23.0 m/min) At No Load 75 – 850 IPM (1.9 – 21.6 m/min) Feeding Wire				

2-2. Duty Cycle And Overheating



A. 115 VAC Model

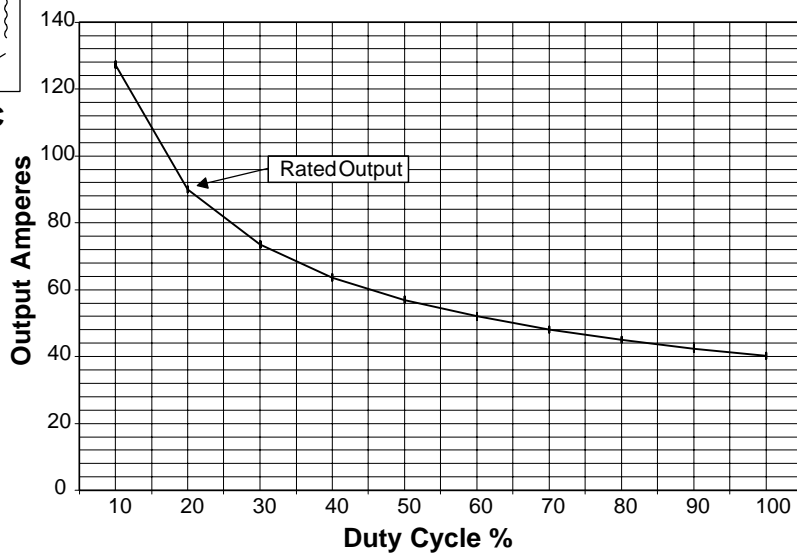

Duty Cycle is percentage of 10 minutes that unit can weld at rated load without overheating.

If unit overheats, thermostat(s) opens, output stops, and cooling fan runs. Wait fifteen minutes for unit to cool. Reduce amperage or duty cycle before welding.

▲ Exceeding duty cycle can damage unit or gun and void warranty.

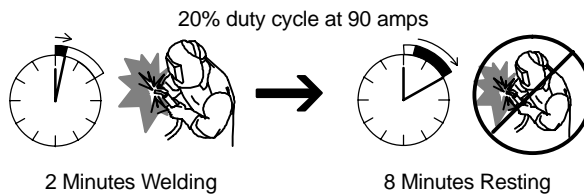

B. 230 VAC Model

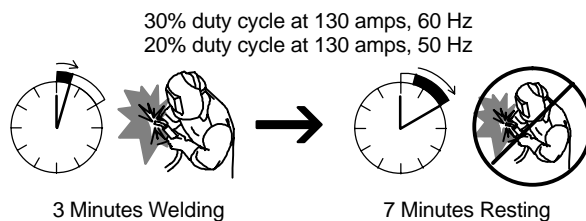
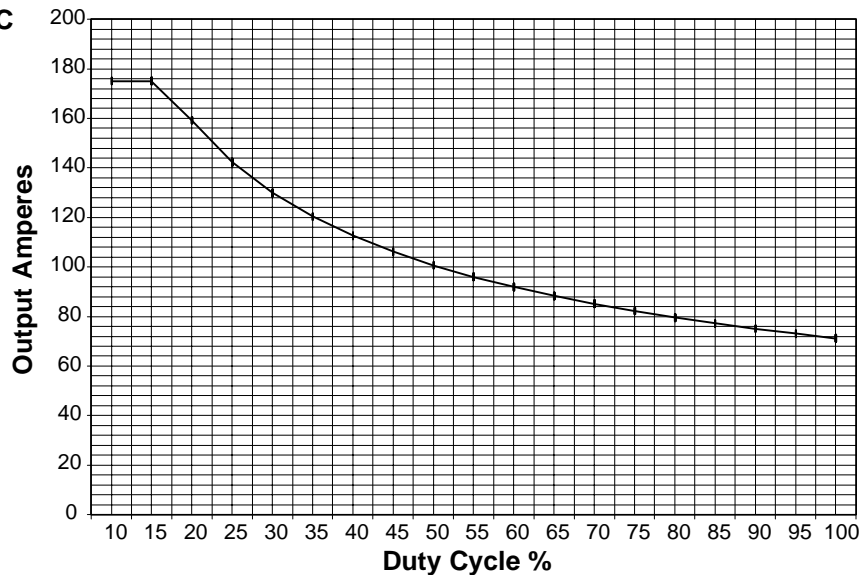

Overheating

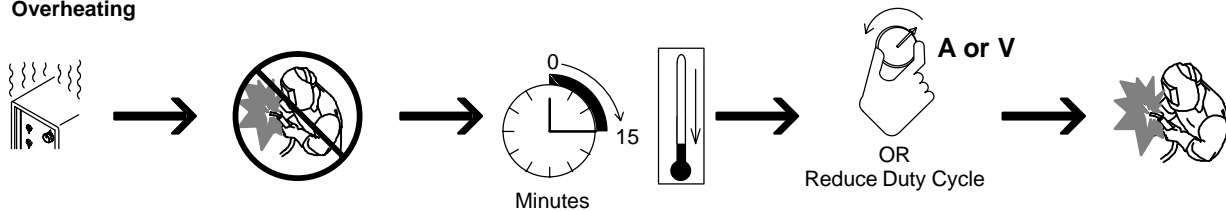

2-3. Volt-Ampere Curves

A. 115 VAC Model

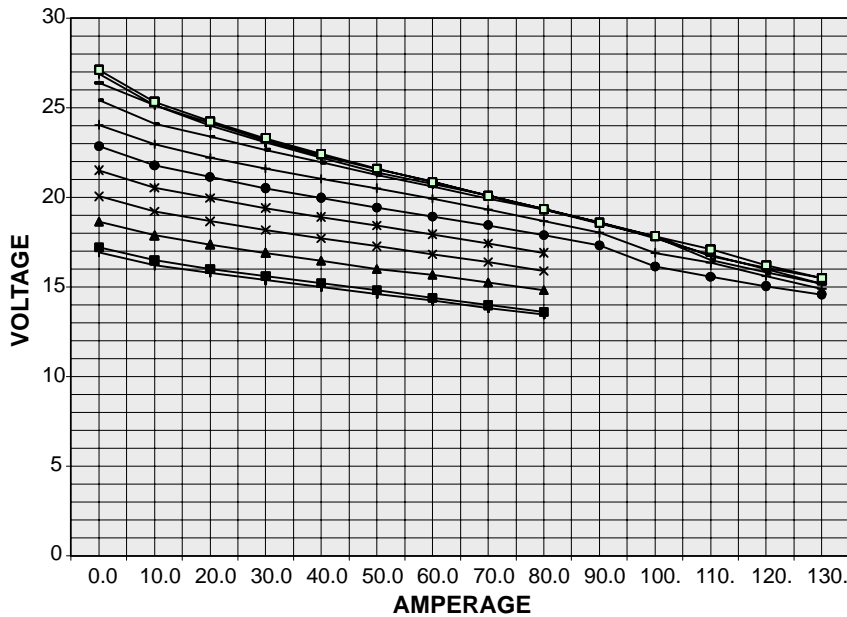

The volt-ampere curves show the minimum and maximum voltage and amperage output capabilities of the welding power source. Curves of other settings fall between the curves shown.

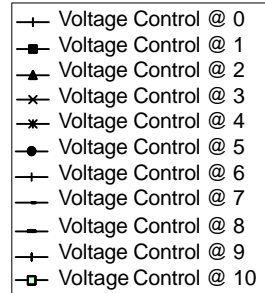

B. 230 VAC Model

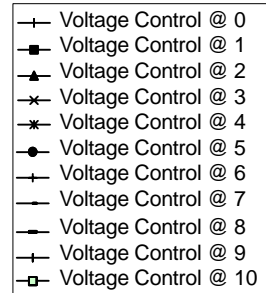
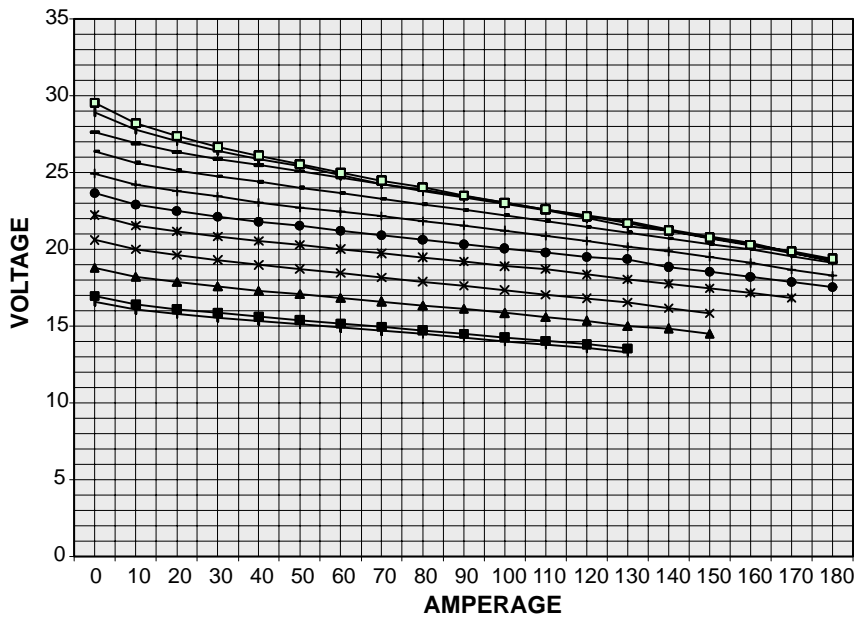

SECTION 3 – INSTALLATION

3-1. Installing Welding Gun

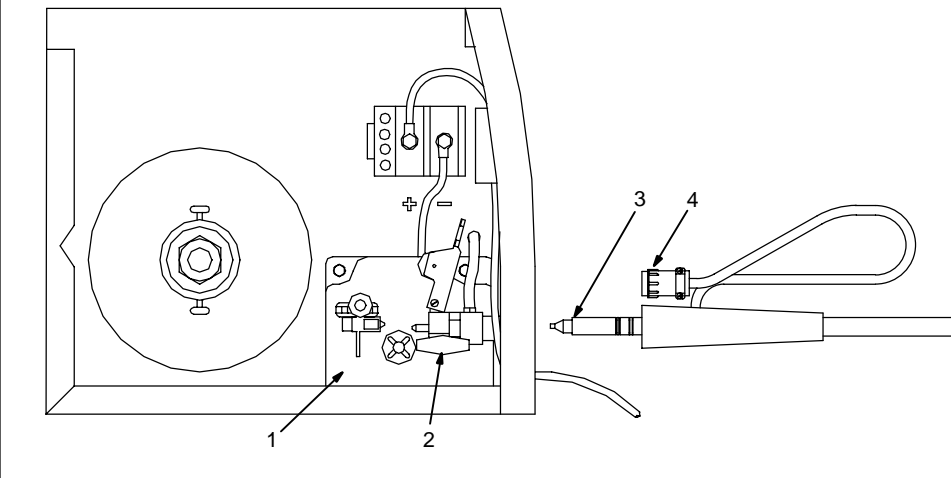

- 1 Drive Assembly
- 2 Gun Securing Knob
- 3 Gun End

Loosen knob. Insert gun end through opening until it bottoms against drive assembly. Tighten knob.

4 Gun Trigger Plug
Insert into receptacle, and tighten threaded collar.

Close door.

Ref. 802 982 / Ref. 801 987

3-2. Installing Work Clamp

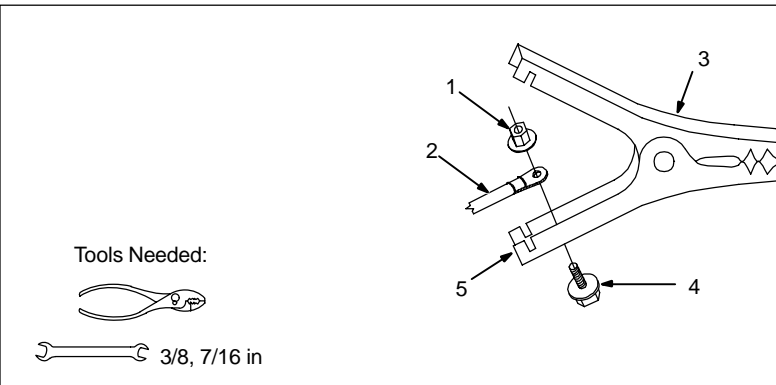

- 1 Nut
 - 2 Work Cable From Unit
 - 3 Work Clamp
 - 4 Screw
 - 5 Work Clamp Tabs
- Bend tabs around work cable.

802 456

3-3. Work Cable Routing Inside Unit

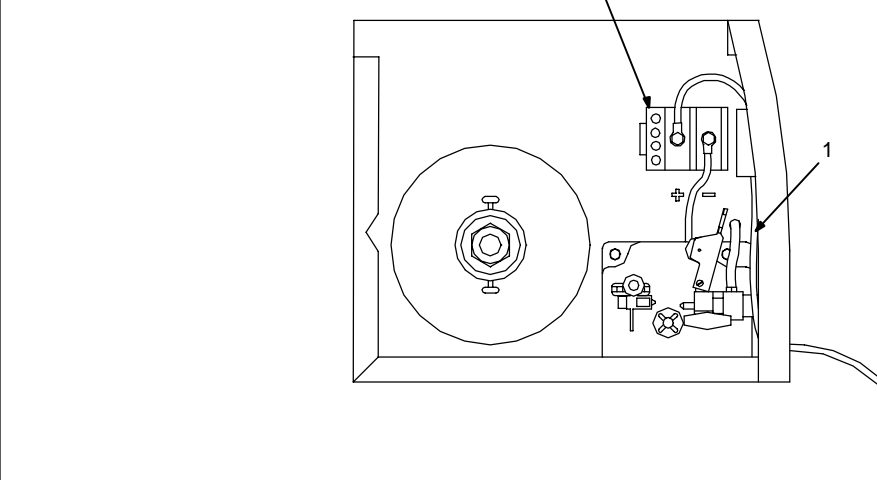

- 1 Work Cable
- 2 Output Terminal Block

Insert work cable through opening in front panel and route along back of front panel to output terminal block.

Close door.

Ref. 802 982

3-4. Process/Polarity Table

Process	Polarity	Cable Connections	
		Cable To Gun	Cable To Work
GMAW – Solid wire with shielding gas	DCEP – Reverse polarity	Connect to positive (+) output terminal	Connect to negative (-) output terminal
FCAW – Self-shielding wire – no shielding gas	DCEN – Straight Polarity	Connect to negative (-) output terminal	Connect to positive (+) output terminal

3-5. Changing Polarity



- 1 Lead Connections For Direct Current Electrode Positive (DCEP)
- 2 Lead Connections For Direct Current Electrode Negative (DCEN)

Always read and follow wire manufacturer's recommended polarity, and see Section 3-4.

Close door.

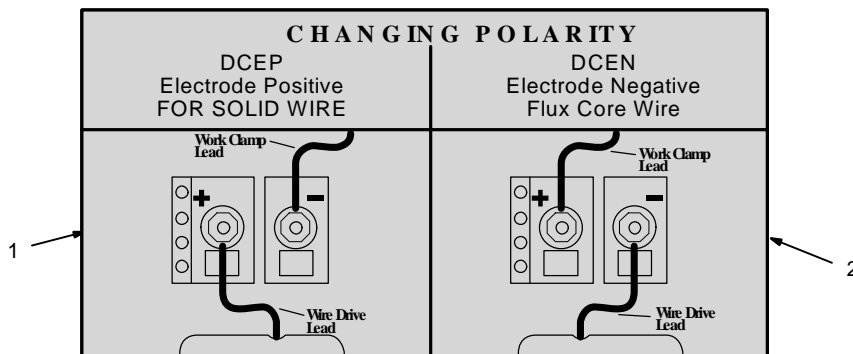

Ref. 203 501

3-6. Installing Gas Supply



Tools Needed:
 5/8, 1-1/8 in

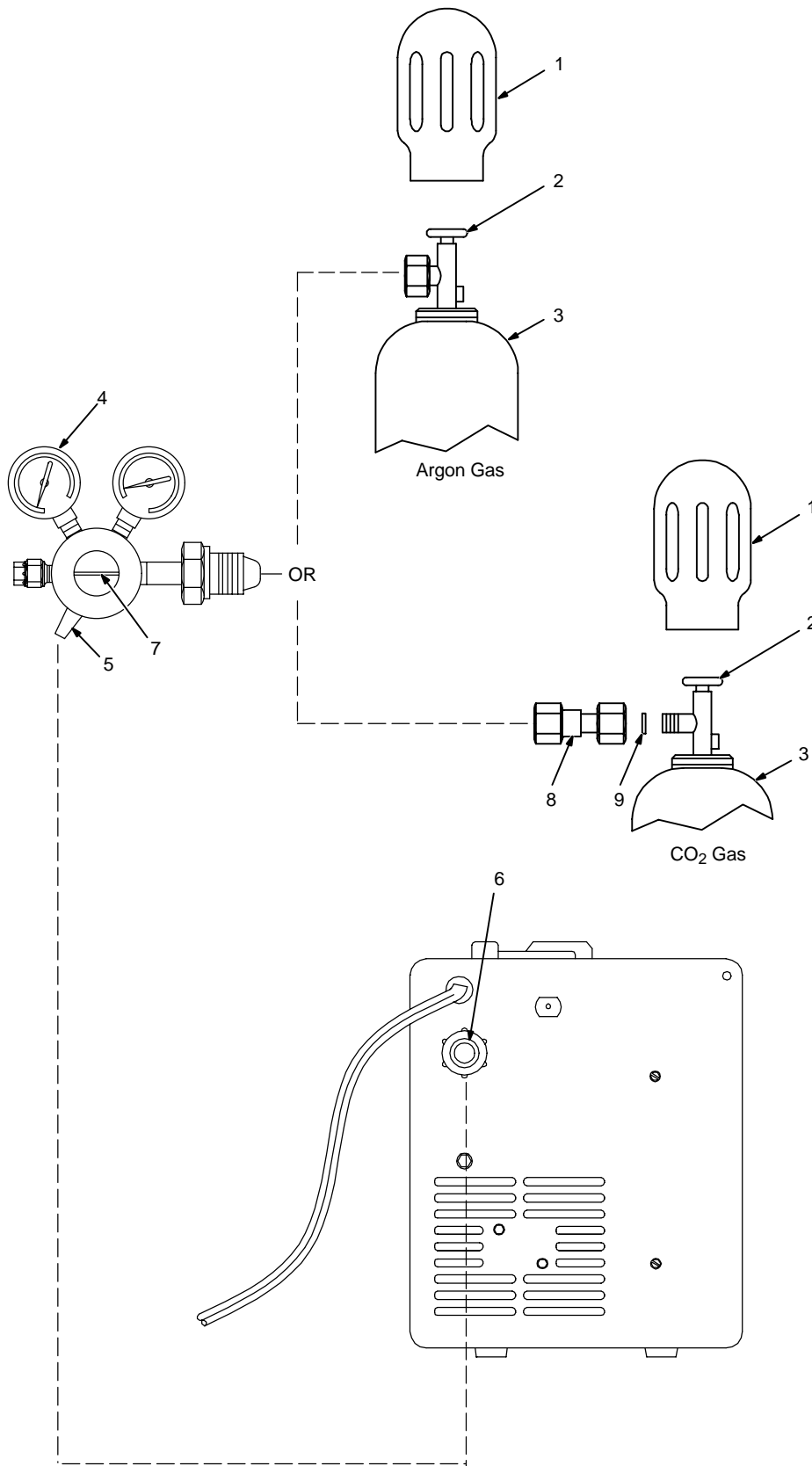

Obtain gas cylinder and chain to running gear, wall, or other stationary support so cylinder cannot fall and break off valve.

- 1 Cap
- 2 Cylinder Valve

Remove cap, stand to side of valve, and open valve slightly. Gas flow blows dust and dirt from valve. Close valve.

- 3 Cylinder
- 4 Regulator/Flowmeter

Install so face is vertical.

- 5 Regulator/Flowmeter Gas Hose Connection
- 6 Welding Power Source Gas Hose Connection

Connect customer supplied gas hose between regulator/flowmeter gas hose connection, and fitting on rear of welding power source.

- 7 Flow Adjust

Typical flow rate is 20 cfh (cubic feet per hour). Check wire manufacturer's recommended flow rate.

- 8 CO₂ Adapter (Customer Supplied)
 - 9 O-Ring (Customer Supplied)
- Install adapter with O-ring between regulator/flowmeter and CO₂ cylinder.

3-7. Selecting A Location And Connecting Input Power For 115 VAC Model

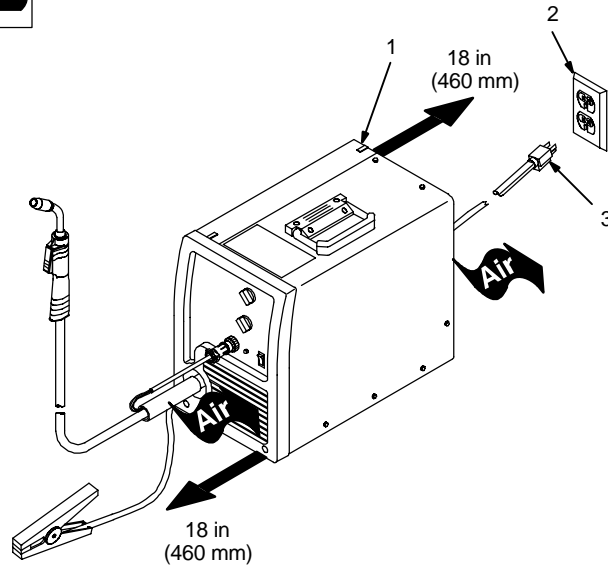

- 1 Rating Label
- 2 Grounded Receptacle

A 115 volt, 20 ampere individual branch circuit protected by time-delay fuses or circuit breaker is required.

- 3 Plug From Unit

Select extension cord of 14 AWG for up to 50 ft (15 m) or 12 AWG for 50 up to 200 ft (61 m).

▲ **Special installation may be required where gasoline or volatile liquids are present – see NEC Article 511 or CEC Section 20.**

Ref. 802 980

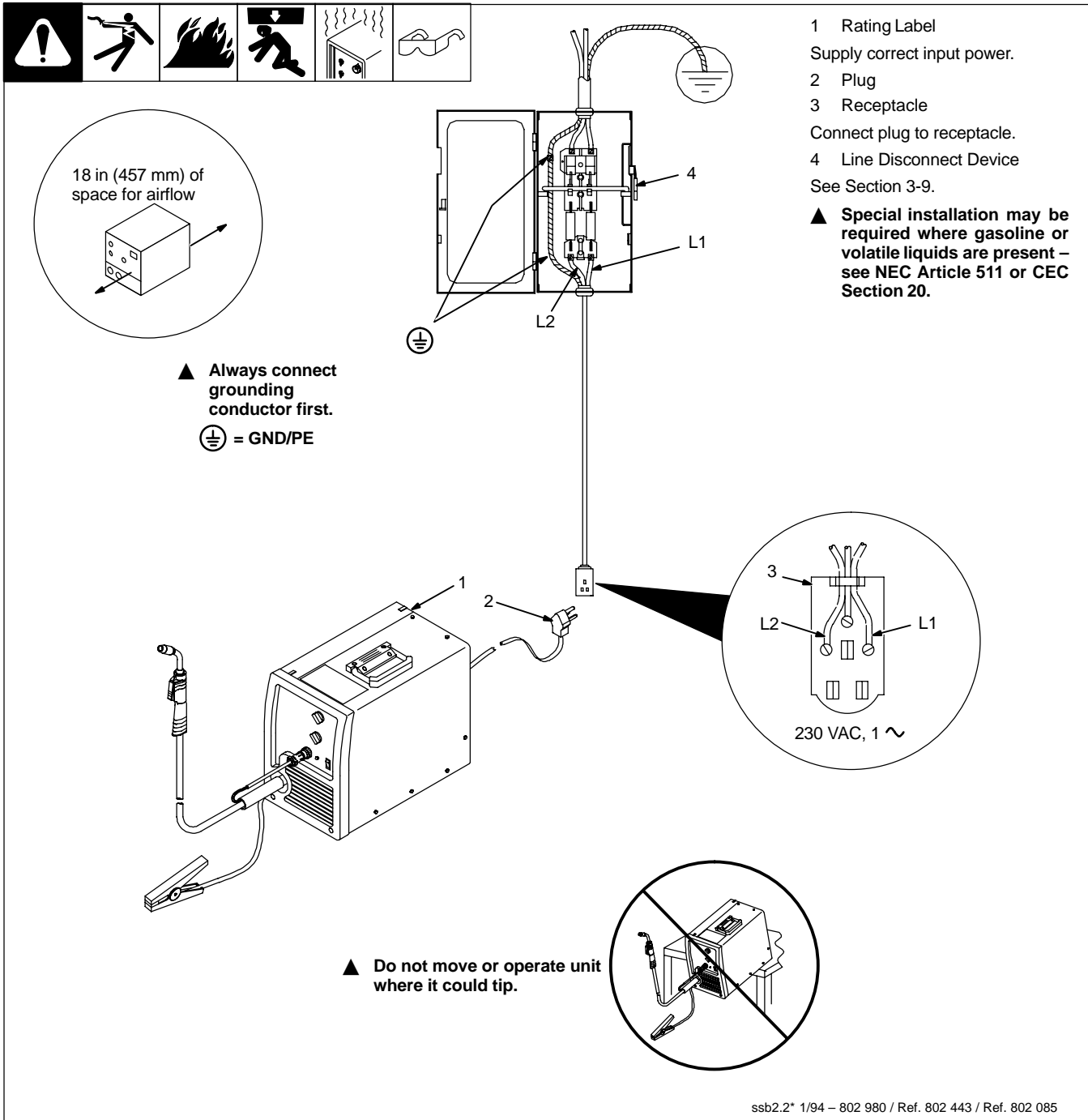

3-8. Selecting A Location And Connecting Input Power For 230 VAC Model



3-9. Electrical Service Guide For 230 VAC Model

Input Voltage	230
Input Amperes At Rated Output	20
Max Recommended Standard Fuse Or Circuit Breaker Rating In Amperes	20
Min Input Conductor Size In AWG/Kcmil	14
Max Recommended Input Conductor Length In Feet (Meters)	66 (20)
Min Grounding Conductor Size In AWG/Kcmil	12
Reference: 1996 National Electrical Code (NEC)	S-0092-J

3-10. Installing Wire Spool And Adjusting Hub Tension

Installing 4 in (102 mm) Wire Spool

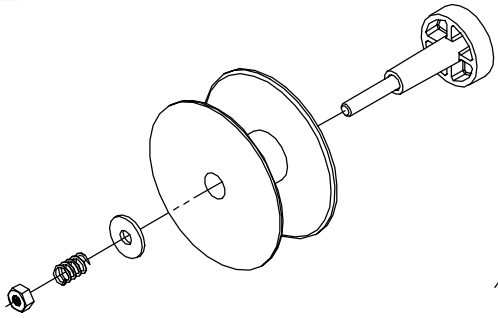

When a slight force is needed to turn spool, tension is set.

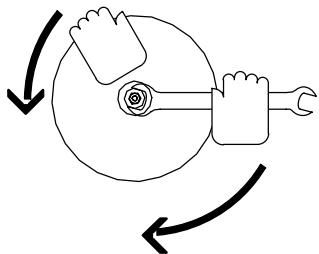

Installing 8 in (203 mm) Wire Spool

Retaining ring used with 8 in (203 mm) spool only.

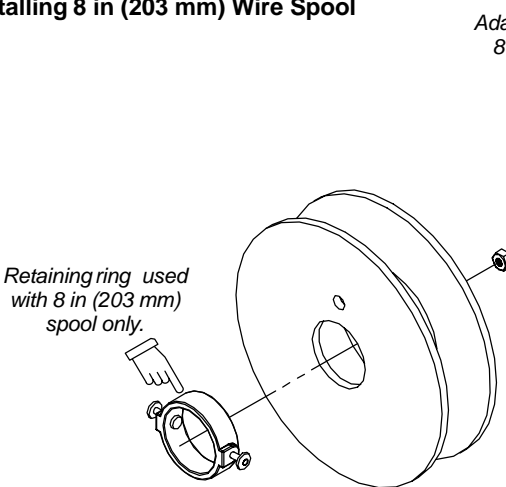

Adapter used with 8 in (203 mm) spool only.

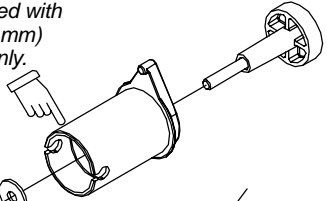

When a slight force is needed to turn spool, tension is set.

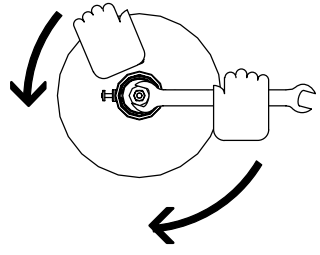

Tools Needed:



1/2 in

802 971 / 803 012 / 803 013

3-11. Threading Welding Wire



- 1 Wire Spool
 - 2 Welding Wire
 - 3 Inlet Wire Guide
 - 4 Pressure Adjustment Knob
 - 5 Drive Roll
 - 6 Gun Conduit Cable
- Lay gun cable out straight.

Tools Needed:

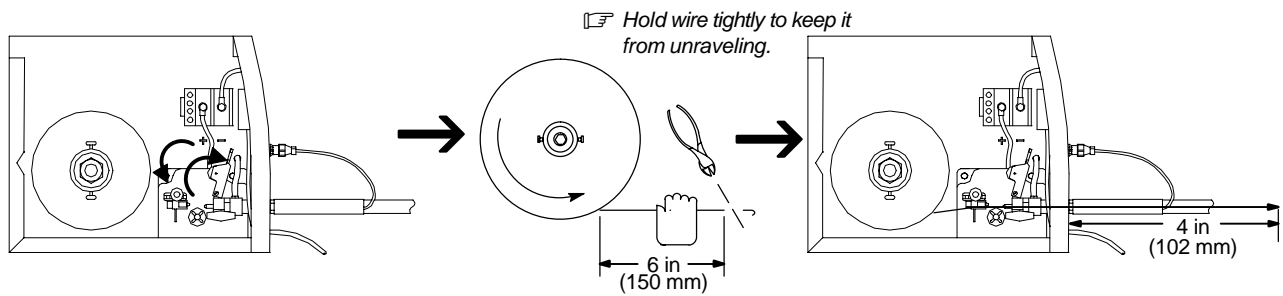
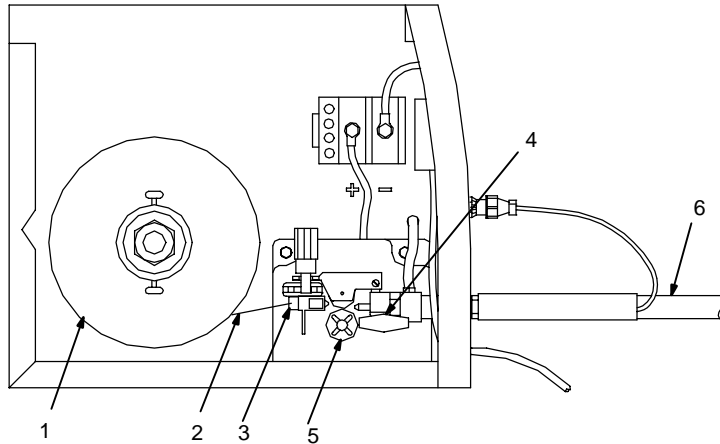
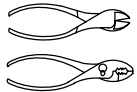

Open pressure assembly.

Pull and hold wire; cut off end.

Push wire thru guides into gun; continue to hold wire.

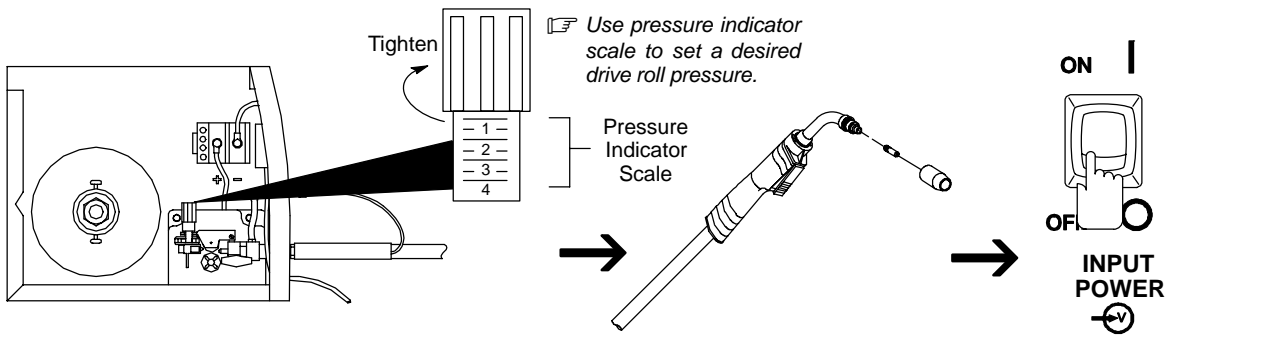

Close and tighten pressure assembly, and let go of wire.

Remove gun nozzle and contact tip.

Turn power on.

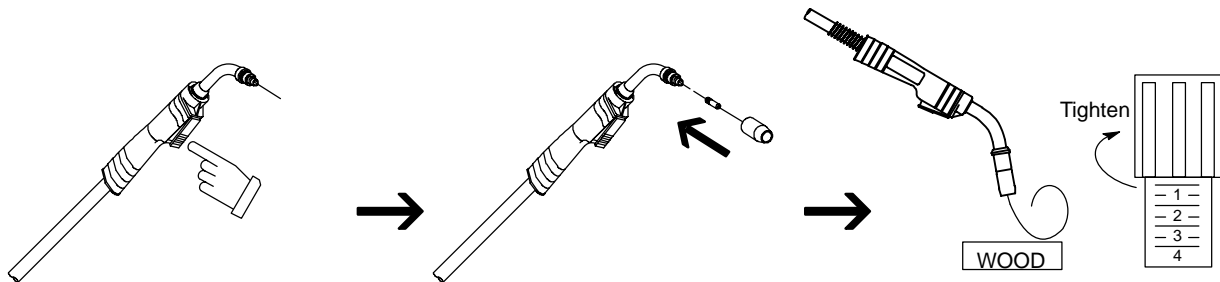

Press gun trigger until wire comes out of gun.

Reinstall contact tip and nozzle.

Feed wire to check drive roll pressure. Tighten knob enough to prevent slipping. Cut off wire. Close door.

SECTION 4 – OPERATION

4-1. Controls

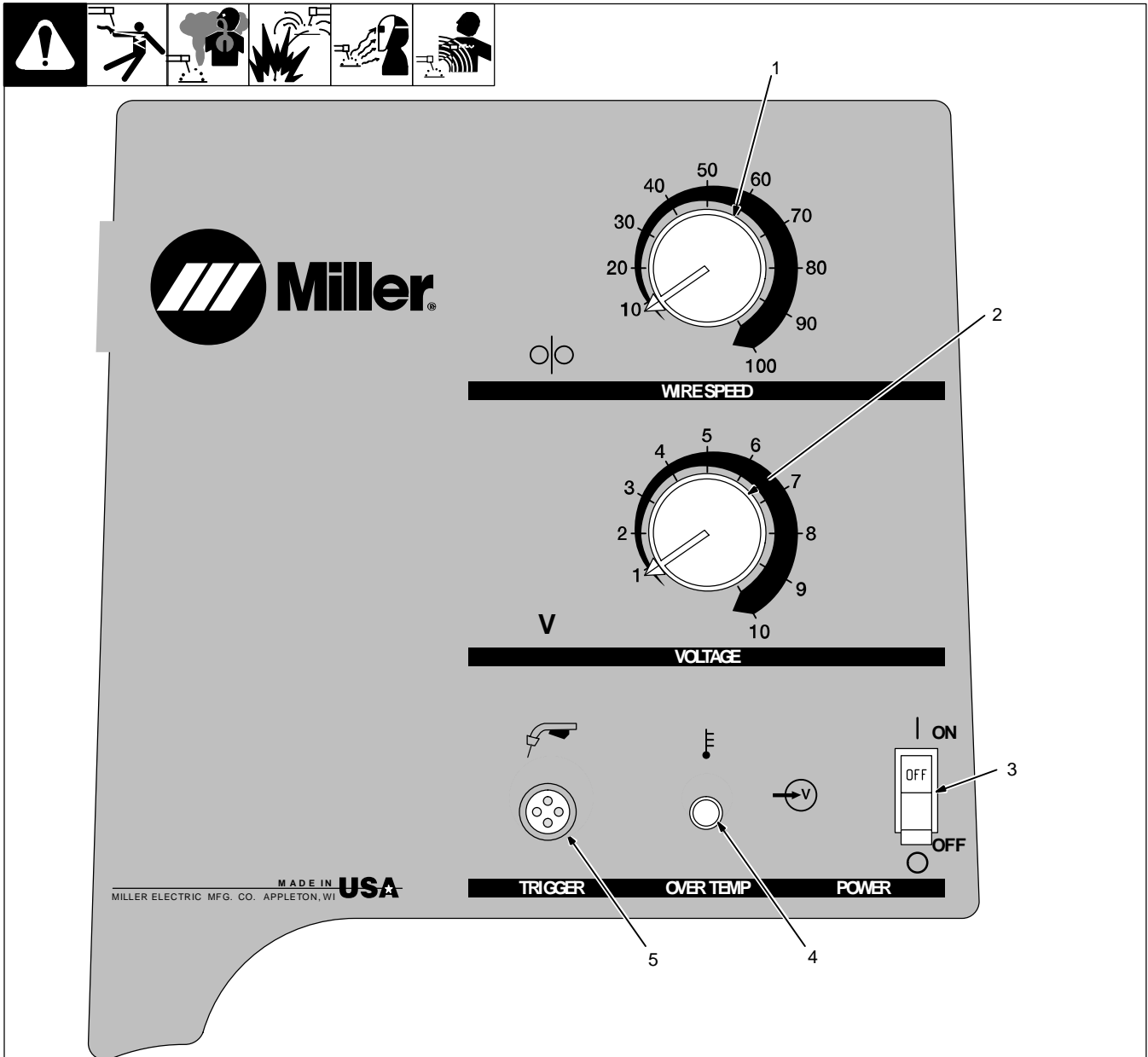

1 Wire Speed Control

Turn control clockwise to increase wire feed speed. (see weld parameter chart in welding power source or Sections 4-2 and 4-3, as applicable).

2 Voltage Control

Turn control clockwise to increase voltage (see weld parameter chart in welding power source or Sections 4-2 and 4-3, as applicable).

3 Power Switch

4 Over Temperature Light

5 Gun Trigger Receptacle

4-2. Weld Parameter Chart For 115 VAC Model

Selecting Wire, Gas and Control Settings





- Note: 1. Settings are approximate. Adjust as required.
 2. "—" Means not recommended.

What Material You are Welding	Suggested Wire Types, Polarity	Suggested Shielding Gases (Flow Rate of 20–30cfh)	Wire Size (Diameters)
Steel	Solid Wire (or Hard) ER70S-6 (DCEP)	C ₂₅ Gas Mixture 75% Ar / 25% CO ₂ (Ar / CO ₂ produces less spatter – better overall appearance)	.024" (0.6 mm) .030" (0.8 mm) .035" (0.9 mm)
	Solid Wire (or Hard) ER70S-6 (DCEP)	100% CO ₂	.024" (0.6 mm) .030" (0.8 mm) .035" (0.9 mm)
	Flux Core E71T-11 (DCEN)	No Shielding Gas required. Good for windy or outdoor applications. May require an oversized tip for improved feedability.	.030" (0.8 mm) .035" (0.9 mm) .045" (1.2 mm)
Stainless Steel	Stainless Steel (DCEP)	Tri-Mix 90% He / 7.5% Ar / 2.5% CO ₂	.030" (0.8 mm)

Select Voltage and Wire Speed Based on Thickness of Metal Being Welded

Number on left of slash
is Voltage Knob Setting.

Number on right of slash
is Wire Speed Knob Setting.

 3/16" (4.8 mm)	 1/8" (3.2 mm)	 16 ga. (1.6 mm)	 20 ga. (0.9 mm)	 24 ga. (0.8 mm)
—	7 / 70	3 / 55	2.5 / 40	2 / 30
—	8 / 75	3.5 / 55	2.5 / 40	2 / 35
—	8 / 75	4 / 45	2 / 25	—
—	9 / 55	4 / 55	3 / 40	—
—	9 / 70	3.5 / 60	2 / 40	—
—	9 / 60	6 / 50	3 / 40	—
7 / 80	5 / 60	3 / 40	—	—
8 / 70	5 / 60	3 / 40	—	—
7.5 / 65	6 / 60	—	—	—
9 / 70	5 / 45	4.5 / 40	—	—

4-3. Weld Parameter Chart For 230 VAC Model

Selecting Wire, Gas and Control Settings

Note: 1. Settings are approximate. Adjust as required.







2. "—" Means not recommended.

What Material You are Welding	Suggested Wire Types, Polarity	Suggested Shielding Gases (Flow Rate of 20–30cfh)	Wire Size (Diameters)
Steel	Solid Wire (or Hard) ER70S-6 (DCEP)	C ₂₅ Gas Mixture 75% Ar / 25% CO ₂ (Ar / CO ₂ produces less spatter – better overall appearance)	.024" (0.6 mm) .030" (0.8 mm) .035" (0.9 mm)
	Solid Wire (or Hard) ER70S-6 (DCEP)	100% CO ₂	.024" (0.6 mm) .030" (0.8 mm) .035" (0.9 mm)
	Flux Core E71T-11 (DCEN)	No Shielding Gas required. Good for windy or outdoor applications. May require an oversized tip for improved feedability.	.030" (0.8 mm) .035" (0.9 mm) .045" (1.2 mm)
Stainless Steel	Stainless Steel (DCEP)	Tri-Mix 90% He / 7.5% Ar / 2.5% CO ₂	.030" (0.8 mm) .035" (0.9 mm)

Select Voltage and Wire Speed Based on Thickness of Metal Being Welded

Number on left of slash
is Voltage Knob Setting.

Number on right of slash
is Wire Speed Knob Setting.

 1/4" (6.4 mm)	 3/16" (4.8 mm)	 1/8" (3.2 mm)	 16 ga. (1.6 mm)	 20 ga. (0.9 mm)	 24 ga. (0.8 mm)
---	--	---	---	---	---

8 / 90	8 / 90	4 / 75	3 / 70	2 / 45	1 / 50
8 / 80	5 / 75	4 / 70	2.5 / 55	1.5 / 60	1.5 / 45
8 / 75	5 / 75	3.5 / 75	3 / 70	2 / 60	—













—	8 / 85	4 / 70	2 / 70	1.5 / 60	—
9.5 / 70	4.5 / 70	3.5 / 60	2.5 / 55	1.5 / 45	—
6.5 / 70	5.5 / 70	4 / 70	3 / 55	1.5 / 40	—

8 / 80	6 / 80	5 / 50	3 / 40	—	—
8 / 70	6 / 75	4 / 70	3 / 45	—	—
5 / 70	5 / 60	4 / 50	3.5 / 40	—	—

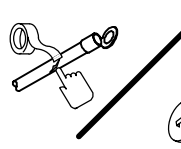

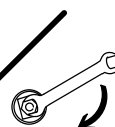
—	7 / 75	4 / 65	3.5 / 45	2.5 / 30	—
—	7 / 75	5 / 70	4.5 / 40	—	—

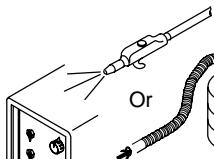
SECTION 5 – MAINTENANCE & TROUBLESHOOTING

5-1. Routine Maintenance

  		▲ Disconnect power before maintaining.
 3 Months		
Replace unreadable labels.		
Repair or replace cracked weld cable.		
Clean and tighten weld terminals.		
 6 Months		
Blow out or vacuum inside. During heavy service, clean monthly.		Or 

5-2. Overload Protection

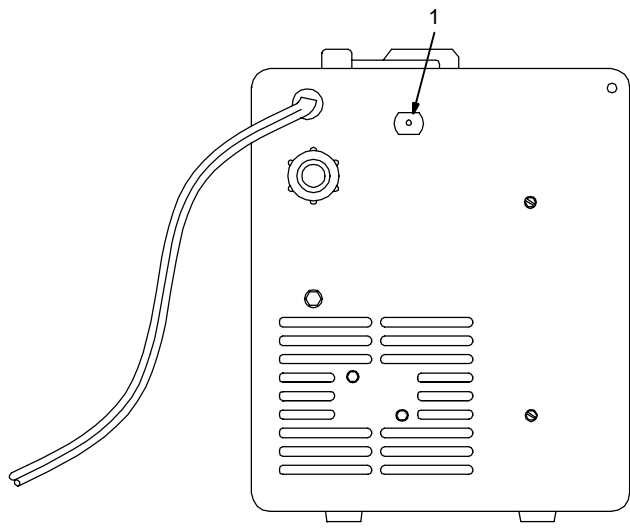
 		1 Circuit Breaker CB1 CB1 protects unit from overload. If CB1 opens, unit shuts down. Reset breaker.
		

802 441

5-3. Drive Motor Protection And Tip Saver/Short Circuit Protection

A. Drive Motor Protection

Drive motor protection circuit protects drive motor from overload. If drive motor becomes inoperative, release gun trigger and wait until protection circuit resets allowing drive motor to feed wire again.

B. Tip Saver/Short Circuit Protection

The tip saver/short circuit protection extends contact tip life and protects internal components from damage. If contact tip is shorted to workpiece, the unit shuts down the welding output, but the fan continues to run. To resume operation, release gun trigger to reset unit. If the contact tip has stuck to the workpiece, release gun trigger, turn off unit, and remove contact tip from workpiece. Check contact tip and replace if damaged. Turn on unit to continue operation.

5-4. Changing Drive Roll Or Wire Inlet Guide

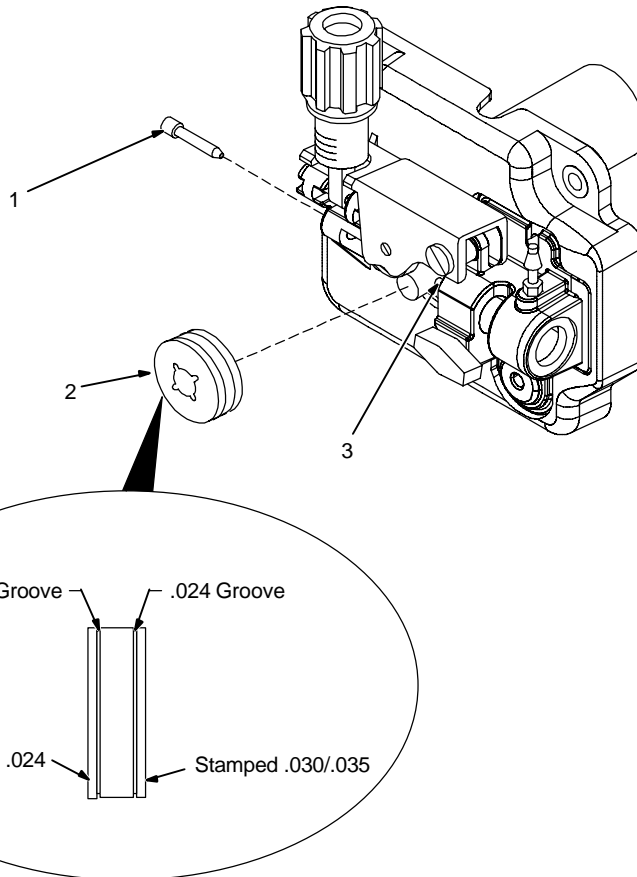

1 Inlet Wire Guide

Remove guide by pressing on barbed area or cutting off one end near housing and pulling it out of hole. Push new guide into hole from rear until it snaps in place.

2 Drive Roll

The drive roll consists of two different sized grooves. The stamped markings on the end surface of the drive roll refers to the groove on the opposite side of the drive roll. The groove closest to the motor shaft is the proper groove to thread (see Section 3-11).

3 Retaining Pin

To secure drive roll, locate open slot and push drive roll completely over retaining pin, then rotate drive roll 20° (1/4 turn) to closed slot.

802 984

5-5. Replacing Gun Contact Tip

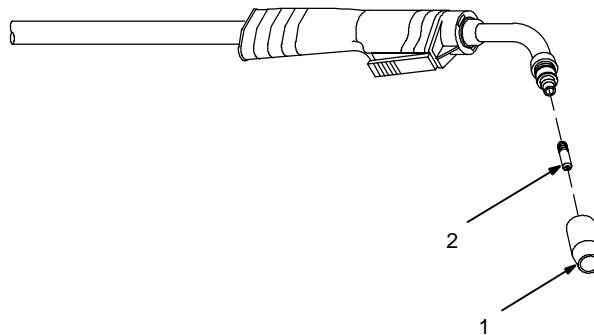

▲ Turn Off power before replacing contact tip.

1 Nozzle

2 Contact Tip

Cut off welding wire at contact tip. Remove nozzle.

Remove contact tip and install new contact tip. Reinstall nozzle.

Tools Needed:

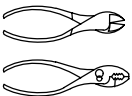

Ref. 802 399-A

5-6. Cleaning Or Replacing Gun Liner

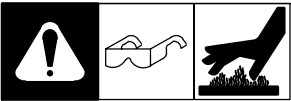

▲ Disconnect gun from unit.

Tools Needed:

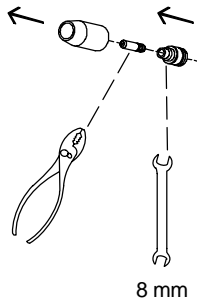
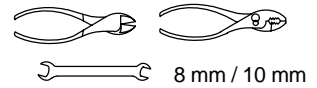

8 mm

Head Tube

Remove nozzle, contact tip, adapter, gas diffuser, and wire outlet guide.

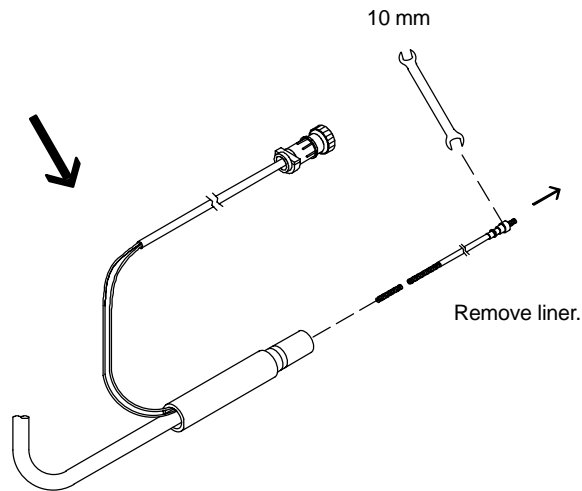

10 mm

Remove liner.

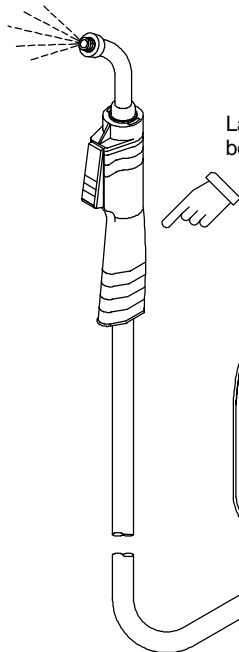

Lay gun cable out straight before installing new liner.

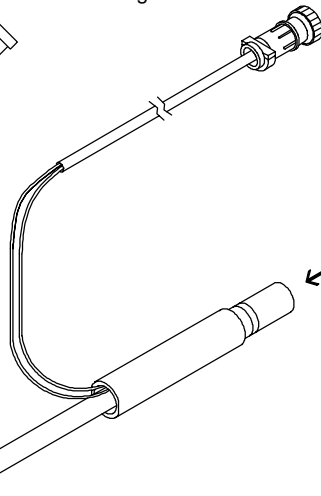

Blow out gun casing.

To Reassemble Gun:

Install and tighten new liner.

Cut liner off 3/4 in (20 mm) (3/8 in [9.5 mm] for aluminum) from head tube.

Install adapter, contact tip, and nozzle.

Ref. ST-802 399-A

5-7. Replacing Switch And/Or Head Tube

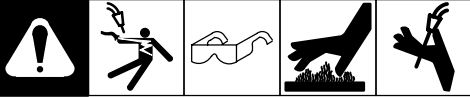

▲ Turn Off welding power source /wire feeder and disconnect gun.

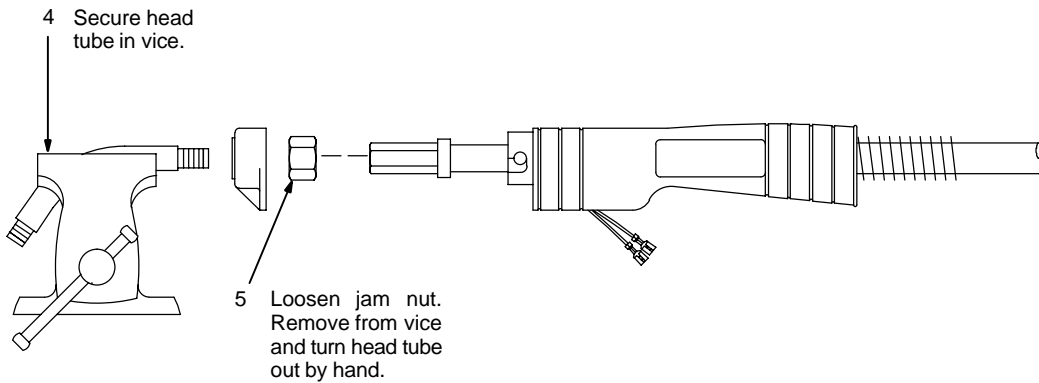
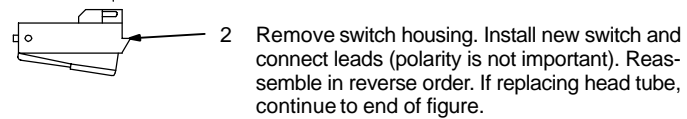
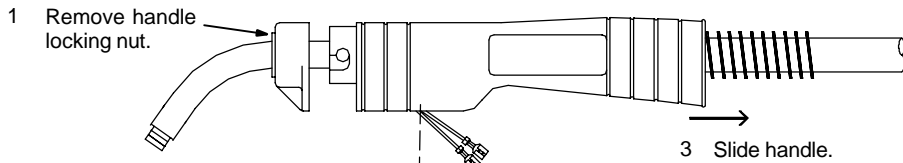

6 Hand-tighten head tube into cable connector.

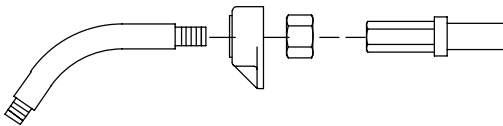

7 Place head tube in vice and tighten until nuts are tight.

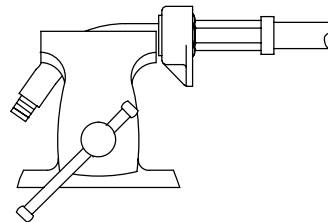

8 Remove from vice. Reposition handle and install switch housing. Secure with handle locking nut.

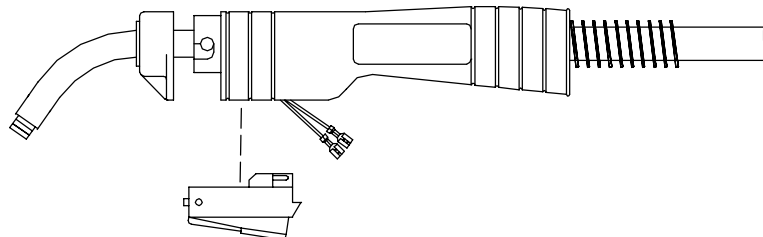

Tools Needed:

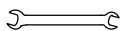

 19 mm

Ref. ST-800 795-C

5-8. Troubleshooting Table

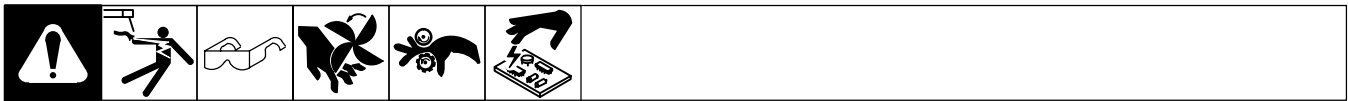

Trouble	Remedy
No weld output; wire does not feed; fan does not run.	Secure power cord plug in receptacle (see Section 3-7).
	Replace building line fuse or reset circuit breaker if open.
	Place Power switch in On position (see Section 4-1).
	Reset welding power source circuit breaker if open.
No weld output; wire does not feed; fan motor continues to run.	Thermostat TP1 open (overheating). Allow fan to run with gun trigger switch off; thermostat closes when unit has cooled (see Section 2-2).
	Secure gun trigger leads (see Section 3-1).
No weld output; wire feeds.	Connect work clamp to get good metal to metal contact.
	Replace contact tip (see Section 5-5).
	Check for proper polarity connections (see Section 3-5).
	Check thumbscrew securing gun end to feed head adapter and tighten if necessary.
Low weld output.	Connect unit to proper input voltage or check for low line voltage.
	Place voltage switch in desired position (see Section 4-1).
Electrode wire feeding stops during welding.	Straighten gun cable and/or replace damaged parts.
	Adjust drive roll pressure (see Section 3-11).
	Change to proper drive roll groove (see Section 5-4).
	Readjust hub tension (see Section 3-10).
	Replace contact tip if blocked (see Section 5-5). Oversized tip may be required for some wires.
	Clean or replace wire inlet guide or liner if dirty or plugged (see Section 5-4 or Section 5-6).
	Replace drive roll or pressure bearing if worn or slipping (see Section 5-4).
	Secure gun trigger leads or repair leads (see Section 3-1).
	Check and clear any restrictions at drive assembly and liner (see Section 3-11 or Section 5-6).
	Release gun trigger and allow gun and motor protection circuitry to reset.
Have nearest Factory Authorized Service Agent check drive motor.	

SECTION 6 – ELECTRICAL DIAGRAM

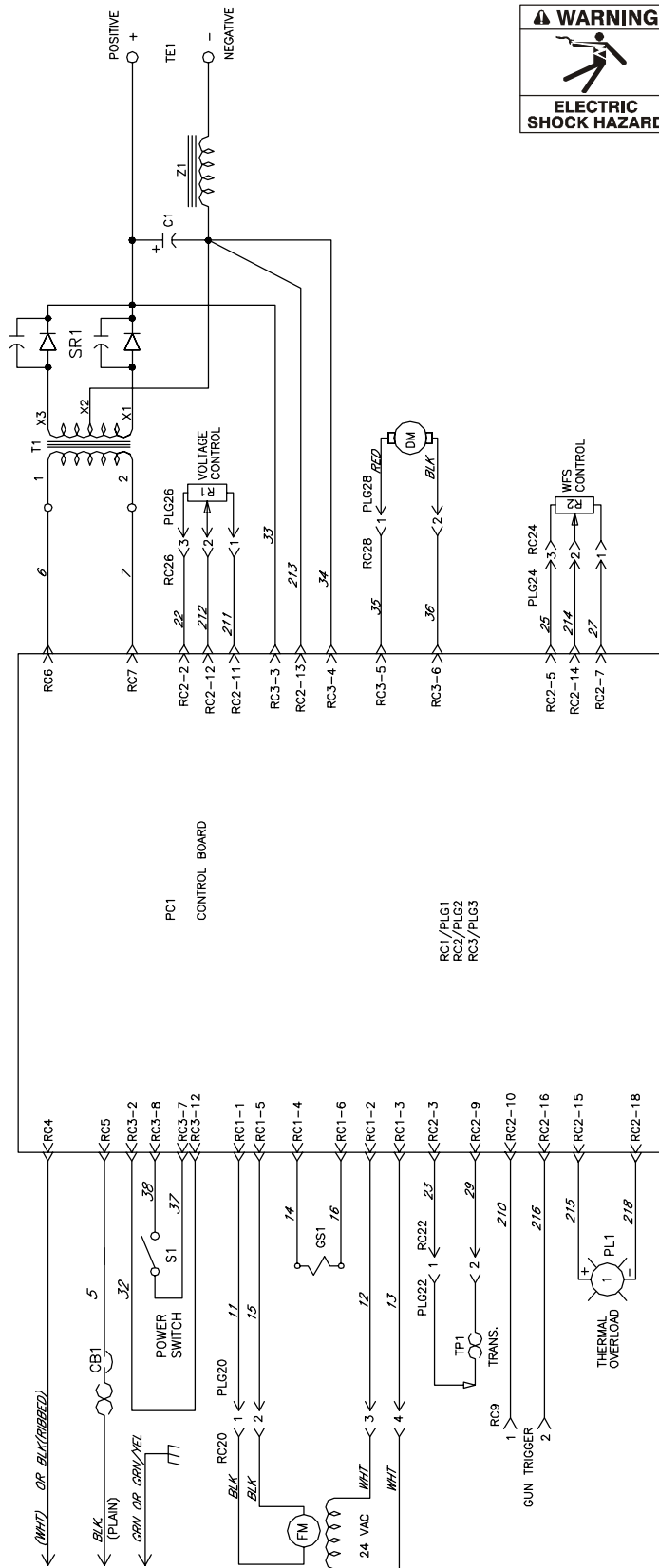

	⚠ WARNING	<ul style="list-style-type: none"> • Do not touch live electrical parts. • Disconnect input power or stop engine before servicing. • Do not operate with covers removed.
	ELECTRIC SHOCK HAZARD	<ul style="list-style-type: none"> • Have only qualified persons install, use, or service this unit.

Figure 6-1. Circuit Diagram For 115 VAC Model

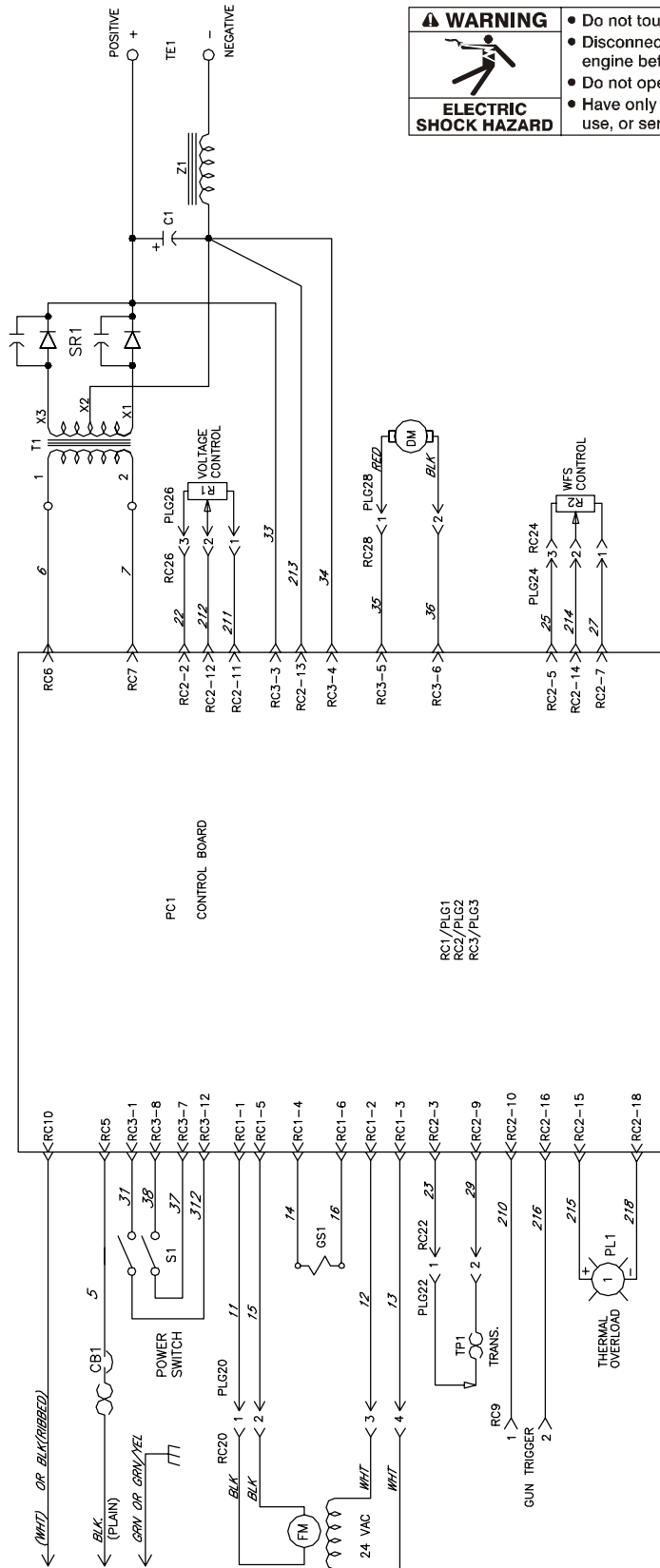

 ELECTRIC SHOCK HAZARD	WARNING
	<ul style="list-style-type: none"> Do not touch live electrical parts. Disconnect input power or stop engine before servicing. Do not operate with covers removed. Have only qualified persons install, use, or service this unit.

Figure 6-2. Circuit Diagram For 230 VAC Model

SECTION 7 – MIG WELDING (GMAW) GUIDELINES



7-1. Typical MIG Process Connections

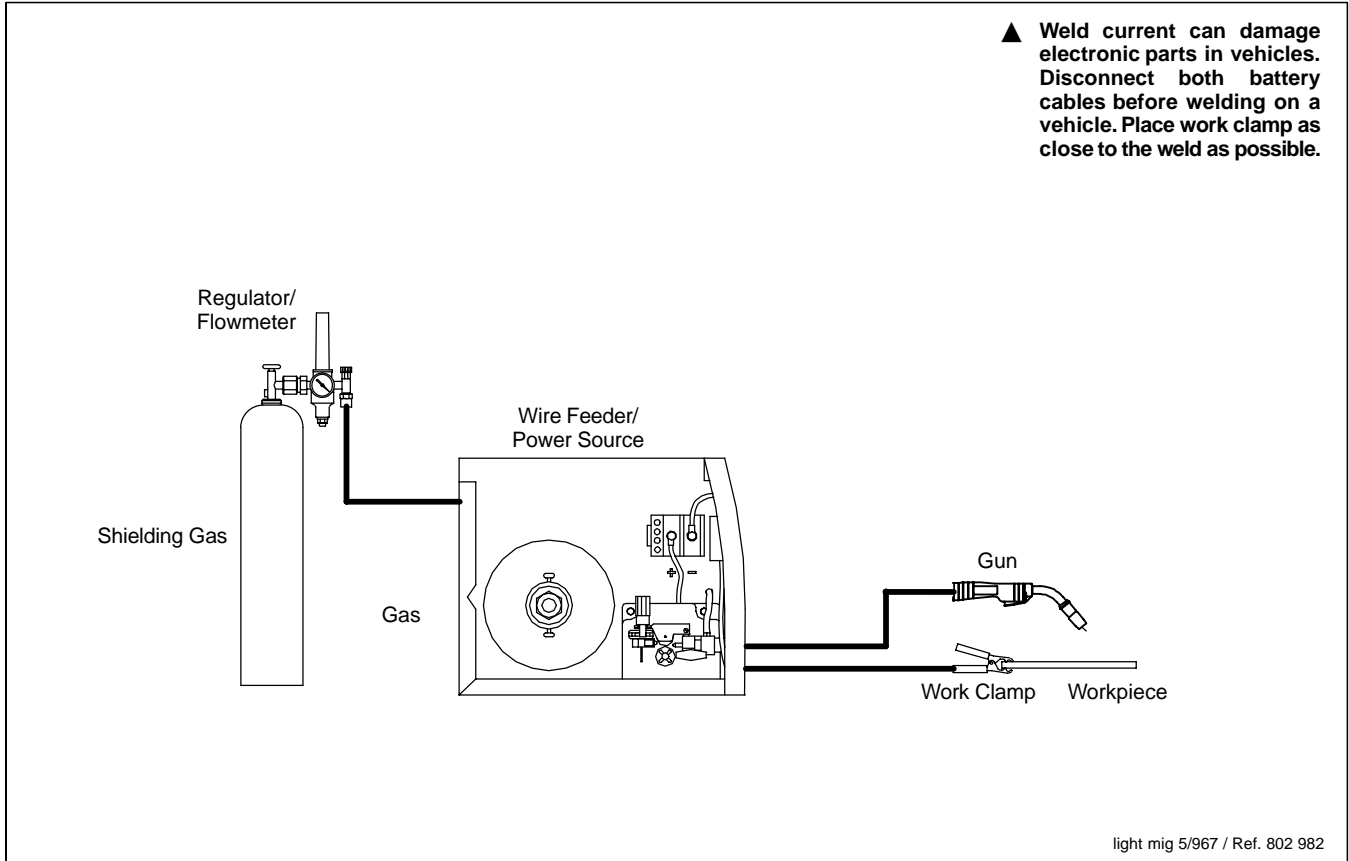

7-2. Typical MIG Process Control Settings

NOTE

These settings are guidelines only. Material and wire type, joint design, fitup, position, shielding gas, etc. affect settings. Test welds to be sure they comply to specifications.

Material thickness determines weld parameters.

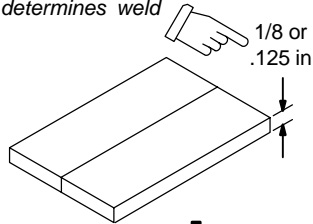

Convert Material Thickness to Amperage (A)

(.001 in = 1 ampere)

.125 in = 125 A

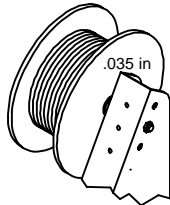

Wire Size	Amperage Range
.023 in	30 – 90 A
.030 in	40 – 145 A
.035 in	50 – 180 A

Select Wire Size

Wire Size	Recommendation	Wire Speed (Approx.)
.023 in	3.5 in per ampere	3.5 x 125 A = 437 ipm
.030 in	2 in per ampere	2 x 125 A = 250 ipm
.035 in	1.6 in per ampere	1.6 x 125 A = 200 ipm

Select Wire Speed (Amperage)

125 A based on 1/8 in material thickness

ipm = inch per minute

Low voltage: wire stubs into work
 High voltage: arc is unstable (spatter)
 Set voltage midway between high/low voltage.

Select Voltage

Wire speed (amperage) controls weld penetration
 (wire speed = burn-off rate)

Voltage controls height and width of weld bead.

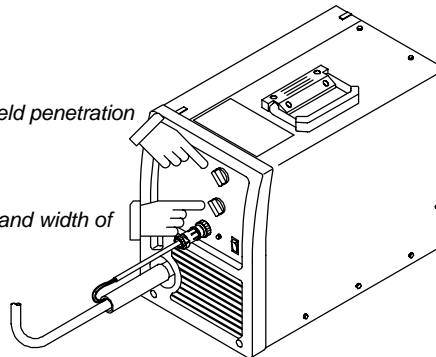

Ref. 802 980

7-3. Holding And Positioning Welding Gun

NOTE 

Welding wire is energized when gun trigger is pressed. Before lowering helmet and pressing trigger, be sure wire is no more than 1/2 in (13 mm) past end of nozzle, and tip of wire is positioned correctly on seam.

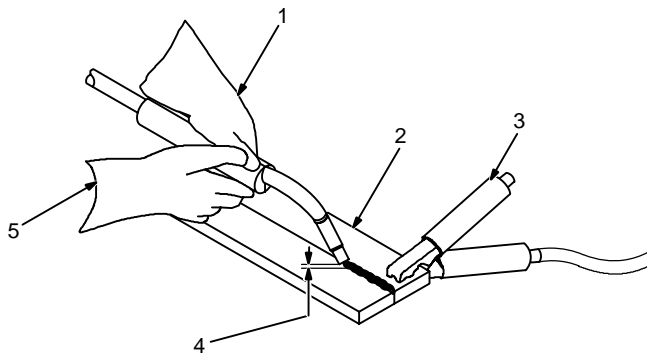

- 1 Hold Gun and Control Gun Trigger
- 2 Workpiece
- 3 Work Clamp
- 4 Electrode Extension (Stickout) 1/4 to 1/2 in (6 To 13 mm)
- 5 Cradle Gun and Rest Hand on Workpiece

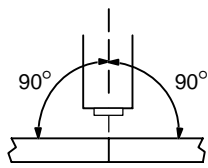

End View Of Work Angle

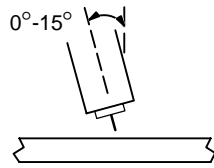

Side View Of Gun Angle

GROOVE WELDS

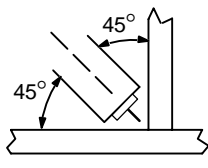

End View Of Work Angle

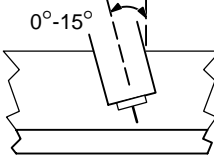

Side View Of Gun Angle

FILLET WELDS

S-0421-A

7-4. Conditions That Affect Weld Bead Shape

NOTE

Weld bead shape depends on gun angle, direction of travel, electrode extension (stickout), travel speed, thickness of base metal, wire feed speed (weld current), and voltage.

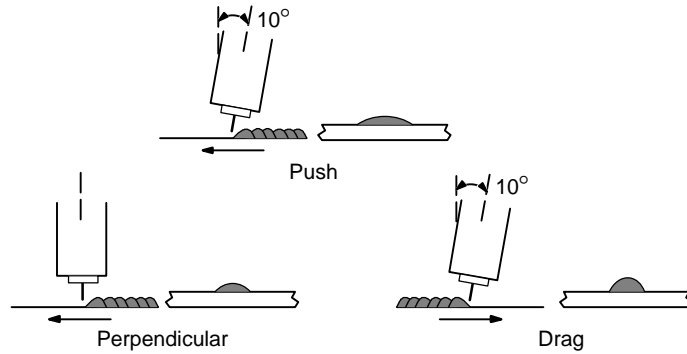

GUN ANGLES AND WELD BEAD PROFILES

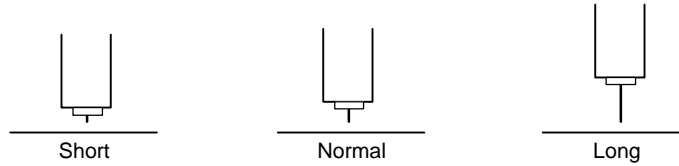

ELECTRODE EXTENSIONS (STICKOUT)

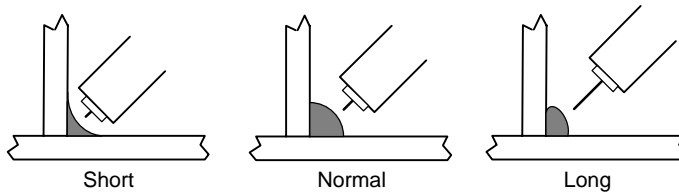

FILLET WELD ELECTRODE EXTENSIONS (STICKOUT)

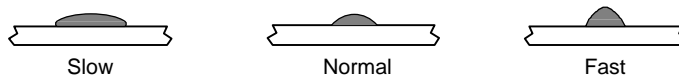

GUN TRAVEL SPEED

S-0634

7-5. Gun Movement During Welding

NOTE

Normally, a single stringer bead is satisfactory for most narrow groove weld joints; however, for wide groove weld joints or bridging across gaps, a weave bead or multiple stringer beads works better.

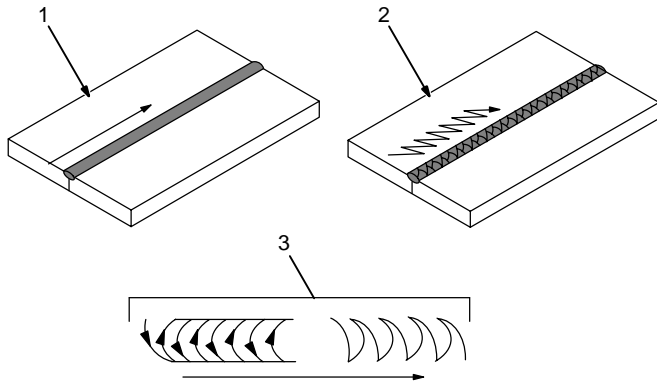

- 1 Stringer Bead – Steady Movement Along Seam
- 2 Weave Bead – Side To Side Movement Along Seam
- 3 Weave Patterns

Use weave patterns to cover a wide area in one pass of the electrode.

S-0054-A

7-6. Poor Weld Bead Characteristics

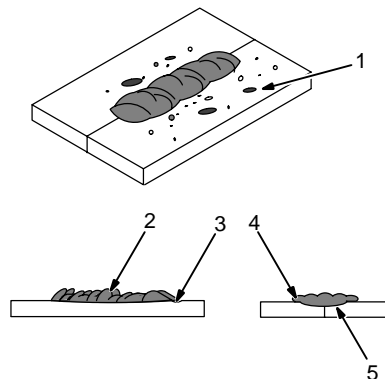

- 1 Large Spatter Deposits
- 2 Rough, Uneven Bead
- 3 Slight Crater During Welding
- 4 Bad Overlap
- 5 Poor Penetration

S-0053-A

7-7. Good Weld Bead Characteristics

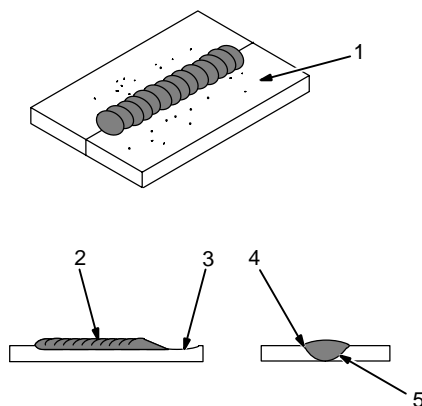

- 1 Fine Spatter
- 2 Uniform Bead
- 3 Moderate Crater During Welding

Weld a new bead or layer for each 1/8 in (3.2 mm) thickness in metals being welded.

- 4 No Overlap
- 5 Good Penetration into Base Metal

S-0052-B

7-8. Troubleshooting – Excessive Spatter

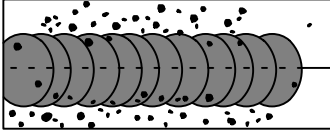

Excessive Spatter – scattering of molten metal particles that cool to solid form near weld bead.

S-0636

Possible Causes	Corrective Actions
Wire feed speed too high.	Select lower wire feed speed.
Voltage too high.	Select lower voltage range.
Electrode extension (stickout) too long.	Use shorter electrode extension (stickout).
Workpiece dirty.	Remove all grease, oil, moisture, rust, paint, undercoating, and dirt from work surface before welding.
Insufficient shielding gas at welding arc.	Increase flow of shielding gas at regulator/flowmeter and/or prevent drafts near welding arc.
Dirty welding wire.	Use clean, dry welding wire.
	Eliminate pickup of oil or lubricant on welding wire from feeder or liner.
Wrong polarity.	Configure polarity as shown in Section 3-5. Always read and follow wire manufacturer's recommended polarity, and see Section 3-4.

7-9. Troubleshooting – Porosity

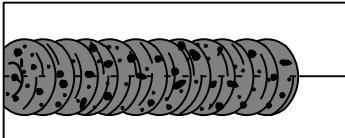

Porosity – small cavities or holes resulting from gas pockets in weld metal.

S-0635

Possible Causes	Corrective Actions
Insufficient shielding gas at welding arc.	Increase flow of shielding gas at regulator/flowmeter and/or prevent drafts near welding arc.
	Remove spatter from gun nozzle.
	Check gas hoses for leaks.
	Place nozzle 1/4 to 1/2 in (6-13 mm) from workpiece.
	Hold gun near bead at end of weld until molten metal solidifies.
Wrong gas.	Use welding grade shielding gas; change to different gas.
Dirty welding wire.	Use clean, dry welding wire.
	Eliminate pick up of oil or lubricant on welding wire from feeder or liner.
Workpiece dirty.	Remove all grease, oil, moisture, rust, paint, coatings, and dirt from work surface before welding.
	Use a more highly deoxidizing welding wire (contact supplier).
Welding wire extends too far out of nozzle.	Be sure welding wire extends not more than 1/2 in (13 mm) beyond nozzle.
Wrong polarity.	Configure polarity as shown in Section 3-5. Always read and follow wire manufacturer's recommended polarity, and see Section 3-4.

7-10. Troubleshooting – Excessive Penetration

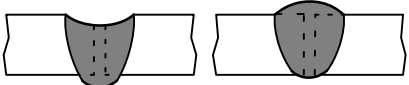
		<p>Excessive Penetration – weld metal melting through base metal and hanging underneath weld.</p>	S-0639
Possible Causes	Corrective Actions		
Excessive heat input.	Select lower voltage range and reduce wire feed speed.		
	Increase travel speed.		
Wrong polarity.	Configure polarity as shown in Section 3-5. Always read and follow wire manufacturer's recommended polarity, and see Section 3-4.		

7-11. Troubleshooting – Lack Of Penetration

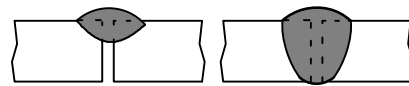
		<p>Lack Of Penetration – shallow fusion between weld metal and base metal.</p>	S-0638
Possible Causes	Corrective Actions		
Improper joint preparation.	Material too thick. Joint preparation and design must provide access to bottom of groove while maintaining proper welding wire extension and arc characteristics.		
Improper weld technique.	Maintain normal gun angle of 0 to 15 degrees to achieve maximum penetration.		
	Keep arc on leading edge of weld puddle.		
	Be sure welding wire extends not more than 1/2 in (13 mm) beyond nozzle.		
Insufficient heat input.	Select higher wire feed speed and/or select higher voltage range.		
	Reduce travel speed.		
Wrong polarity.	Configure polarity as shown in Section 3-5. Always read and follow wire manufacturer's recommended polarity, and see Section 3-4.		

7-12. Troubleshooting – Incomplete Fusion

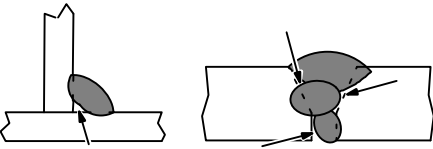
		<p>Incomplete Fusion – failure of weld metal to fuse completely with base metal or a preceding weld bead.</p>	S-0637
Possible Causes	Corrective Actions		
Workpiece dirty.	Remove all grease, oil, moisture, rust, paint, undercoating, and dirt from work surface before welding.		
Insufficient heat input.	Select higher voltage range and/or adjust wire feed speed.		
Improper welding technique.	Place stringer bead in proper location(s) at joint during welding.		
	Adjust work angle or widen groove to access bottom during welding.		
	Momentarily hold arc on groove side walls when using weaving technique.		
	Keep arc on leading edge of weld puddle.		
	Use correct gun angle of 0 to 15 degrees.		
Wrong polarity.	Configure polarity as shown in Section 3-5. Always read and follow wire manufacturer's recommended polarity, and see Section 3-4.		

7-13. Troubleshooting – Burn-Through

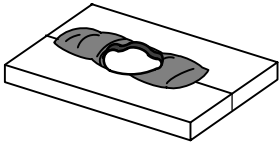
 <p>Burn-Through – weld metal melting completely through base metal resulting in holes where no metal remains.</p> <p style="text-align: right;">S-0640</p>	
Possible Causes	Corrective Actions
Excessive heat input.	Select lower voltage range and reduce wire feed speed.
	Increase and/or maintain steady travel speed.
Wrong polarity.	Configure polarity as shown in Section 3-5. Always read and follow wire manufacturer's recommended polarity, and see Section 3-4.

7-14. Troubleshooting – Waviness Of Bead

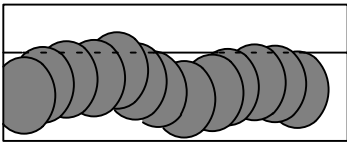
 <p>Waviness Of Bead – weld metal that is not parallel and does not cover joint formed by base metal.</p> <p style="text-align: right;">S-0641</p>	
Possible Causes	Corrective Actions
Welding wire extends too far out of nozzle.	Be sure welding wire extends not more than 1/2 in (13 mm) beyond nozzle.
Unsteady hand.	Support hand on solid surface or use two hands.

7-15. Troubleshooting – Distortion

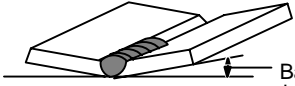
 <p>Distortion – contraction of weld metal during welding that forces base metal to move.</p> <p>Base metal moves in the direction of the weld bead.</p> <p style="text-align: right;">S-0642</p>	
Possible Causes	Corrective Actions
Excessive heat input.	Use restraint (clamp) to hold base metal in position.
	Make tack welds along joint before starting welding operation.
	Select lower voltage range and/or reduce wire feed speed.
	Increase travel speed.
	Weld in small segments and allow cooling between welds.

7-16. Common MIG Shielding Gases

This is a general chart for common gases and where they are used. Many different combinations (mixtures) of shielding gases have been developed over the years. The most commonly used shielding gases are listed in the following table.

Gas	Application			
	Spray Arc Steel	Short Circuiting Steel	Short Circuiting Stainless Steel	Short Circuiting Aluminum
Argon				All Positions
Argon + 25% CO ₂	Flat & Horizontal ¹ Fillet	All Positions	All Positions ²	
CO ₂	Flat & Horizontal ¹ Fillet	All Positions		
Tri-Mix ³			All Positions	

1 Globular Transfer

2 Single Pass Welding Only

3 90% HE + 7-1/2% AR + 2-1/2% CO₂

SECTION 8 – PARTS LIST

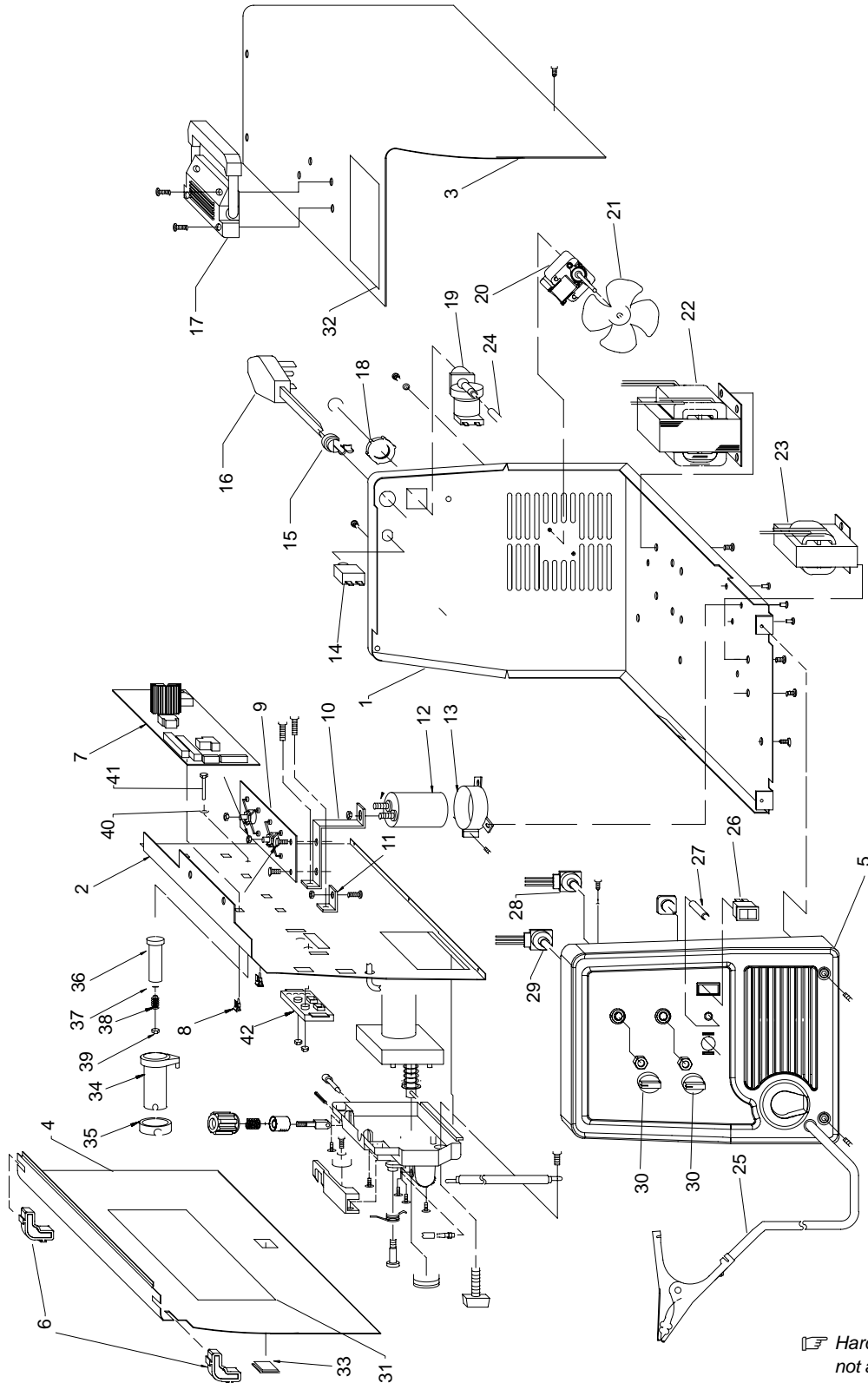

 Hardware is common and not available unless listed.

Figure 8-1. Main Assembly

Item No.	Dia. Mkgs.	Part No.	Description	Quantity
Figure 8-1. Main Assembly				
... 1		202 581	BASE, lower	1
... 2		202 582	BAFFLE, center	1
... 3		202 583	WRAPPER, cover	1
... 4		202 584	DOOR, access	1
... 5		202 411	PANEL, front	1
... 6		202 412	HINGE, door	2
... 7	PC1	199 820	CIRCUIT CARD ASSY, control	1
... 7	PC1	202 354	CIRCUIT CARD ASSY, control	1
... 8		134 201	STAND-OFF support PC board	8
... 9	SK1	193 191	RECTIFIER ASSY (115 VAC model)	1
... 9	SK1	193 316	RECTIFIER ASSY (230 VAC model)	1
... 10		204 215	BUS BAR (positive)	1
... 11		193 194	BUS BAR (negative)	1
... 12	C1	193 039	CAPACITOR, elctlt 53,000 uf (115 VAC model)	1
... 12	C1	193 040	CAPACITOR, elctlt 100,000 uf (230 VAC model)	1
... 13		203 491	CLAMP, capacitor	1
... 14	CB1	210 109	CIRCUIT BREAKER, 25 amp	1
... 15		111 433	BUSHING, strain relief	1
... 16		147 545	CORD SET (115 VAC model)	1
... 16		152 118	CORD SET (230 VAC model)	1
... 17		195 585	HANDLE, carrying	1
... 18		605 227	NUT	1
... 19	GS1	116 996	VALVE, 2 way (115 VAC model)	1
... 19	GS1	128 751	VALVE, 2 way (230 VAC model)	1
... 20	FM	196 063	MOTOR, fan (115 VAC model)	1
... 20	FM	196 064	MOTOR, fan (230 VAC model)	1
... 21		409 953-001	BLADE, fan cooling	1
... 22	T1	203 445	TRANSFORMER (115 VAC model)	1
... 22	T1	203 456	TRANSFORMER (230 VAC model)	1
... 23	Z1	203 868	STABILIZER, 90A (115 VAC model)	1
... 23	Z1	203 874	STABILIZER, 130A (230 VAC model)	1
... 24		196 467	TUBING, pvc	1
... 25		196 619	WORK CABLE	1
... 26	S1	196 575	SWITCH, rocker SPST (115 VAC model)	1
... 26	S1	196 574	SWITCH, rocker DPDT (230 VAC model)	1
... 27	PL1	202 661	LED, yellow	1
... 28	R1	202 663	POTENTIOMETER, cp flat 1T .50W 50k	1
... 29	R2	202 662	POTENTIOMETER, cp flat 1T .25W 50k	1
... 30		205 882	KNOB, pointer	2

+When ordering a component originally displaying a precautionary label, the label should also be ordered.

To maintain the factory original performance of your equipment, use only Manufacturer's Suggested Replacement Parts. Model and serial number required when ordering parts from your local distributor.

Item No.	Dia. Mkgs.	Part No.	Description	Quantity
Figure 8-1. Main Assembly (Continued)				
... 31		203 501	... LABEL, weld guide (115 VAC model)	1
... 31		203 765	... LABEL, weld guide (230 VAC model)	1
... 32		204 036	... LABEL, precautionary static	1
... 33		204 711	... LATCH, slide flush snap lock	1
... 34		202 725	... HUB, spool	1
... 35		058 427	... RING, retaining spool	1
... 36		202 726	... ADAPTER, spool hub	1
... 37		203 072	... WASHER, flat	1
... 38		202 998	... SPRING, cprsn	1
... 39		204 608	... NUT	1
... 40		602 211	... WASHER, lock	1
... 41		203 071	... SCREW	1
... 42	TE1	193 144	... INSULATOR, output stud	1

+When ordering a component originally displaying a precautionary label, the label should also be ordered.

To maintain the factory original performance of your equipment, use only Manufacturer's Suggested Replacement Parts. Model and serial number required when ordering parts from your local distributor.

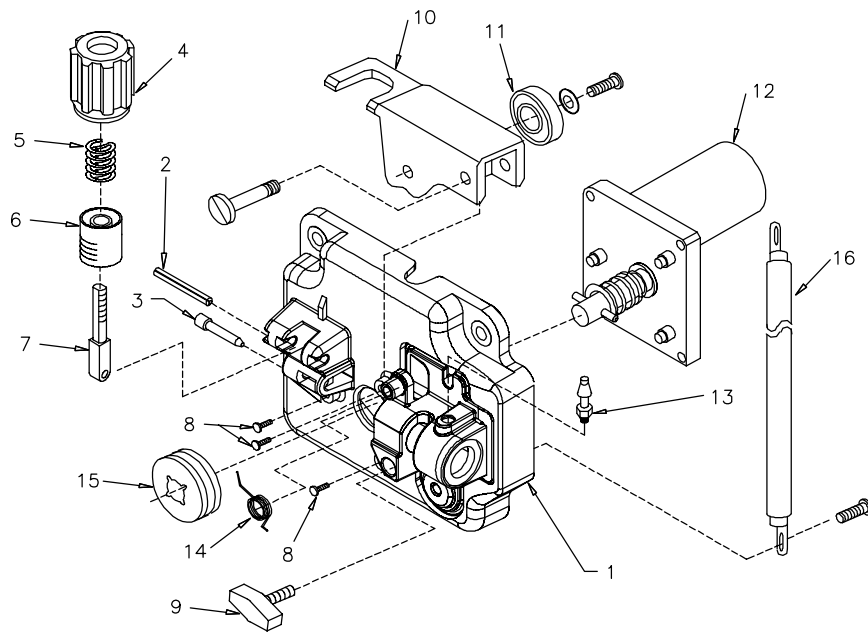

203 565

Figure 8-2. Wire Feed Drive Assembly

Item No.	Dia. Mkgs.	Part No.	Description	Quantity
----------	------------	----------	-------------	----------

Figure 8-2. Wire Feed Drive Assembly

... 1		202 500	HOUSING, plastic drive motor	1
... 2		203 424	PIN, spring	1
... 3		058 549	GUIDE, wire inlet	1
... 4		196 895	KNOB, tension	1
... 5		090 415	SPRING, compression	1
... 6		198 080	CUP, spring tension	1
... 7		085 242	FASTENER, pinned	1
... 8		203 567	SCREW, motor	3
... 9		204 246	KNOB, tee	1
... 10		203 301	LEVER, pressure	1
... 11		189 915	BEARING, ball	1
... 12	DM	202 708	MOTOR, gear	1
... 13		196 009	FITTING, gas	1
... 14		203 418	SPRING, torsion	1
... 15		202 925	ROLL, feed .024, .030/.035	1
... 16		203 667	CABLE	1

+When ordering a component originally displaying a precautionary label, the label should also be ordered.

To maintain the factory original performance of your equipment, use only Manufacturer's Suggested Replacement Parts. Model and serial number required when ordering parts from your local distributor.

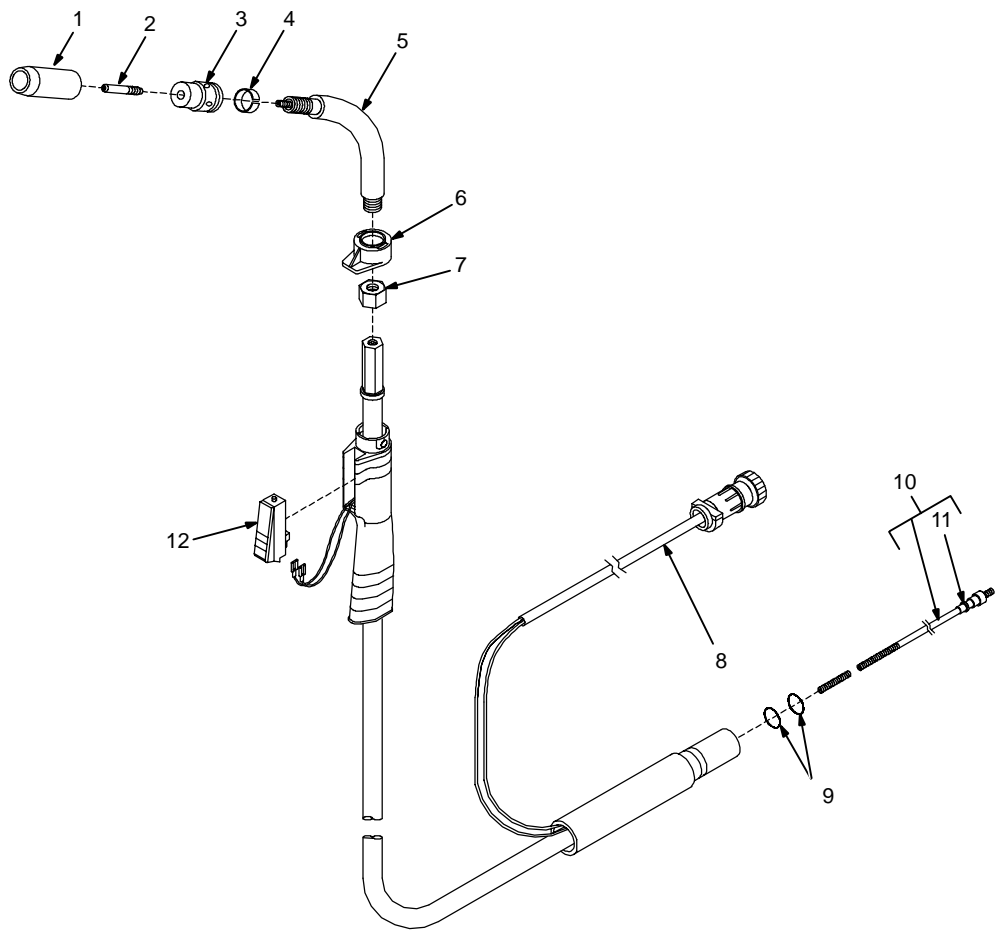

Figure 8-3. M-10 Gun

802 388-A

Item No.	Part No.	Description	Quantity
Figure 8-3. M-10 Gun			
... 1	169 715	.. NOZZLE, slip type .500 orf flush	1
... 2	◆087 299	.. TIP, contact scr .023 wire x 1.125	
... 2	◆000 067	.. TIP, contact scr .030 wire x 1.125	
... 2	◆000 068	.. TIP, contact scr .035 wire x 1.125	
... 2	◆000 069	.. TIP, contact scr .045 wire x 1.125	
... 3	169 716	.. ADAPTER, contact tip	1
... 4	170 470	.. RING, retaining	1
... 5	169 718	.. TUBE, head	1
... 6	169 738	.. NUT, locking handle	1
... 7	194 524	.. NUT, jam	1
... 8	180 433	.. CORD, trigger assembly	1
... 9	079 974	.. O-RING, .500 ID x .103CS rbr	2
... 10	◆194 010	.. LINER, monocoil .023/.025 wire x 15ft (consisting of)	1
... 10	◆194 011	.. LINER, monocoil .030/.035 wire x 15ft (consisting of)	1
... 10	◆194 012	.. LINER, monocoil .035/.045 wire x 15ft (consisting of)	1
... 11	079 975	.. O-RING, .187 ID x .103CS rbr	1
... 12	196 255	.. SWITCH, trigger	1

◆OPTIONAL

To maintain the factory original performance of your equipment, use only **Manufacturer's Suggested Replacement Parts**. Model and serial number required when ordering parts from your local distributor.

Table 8-1. Optional Drive Rolls

For All Feed Head Assemblies	
PART NO.	WIRE DIAMETER INCHES (mm)
202 925	.024 (.6) and .030/.035 (.8 and .9)
202 926	.030/.035 (.8 and .9) and .045 (1.2 VK Groove)

Table 8-2. Options

PART NO.	DESCRIPTION	REMARKS
770 187	Running Gear/Cylinder Rack	For One Small Gas Cylinder, 100 lb (45 kg)
194 776	Small Running Gear/Cylinder Rack	For One Small Gas Cylinder, 75 lb (34 kg)
195 605	M-10 Replacement Gun	10 ft length/.030-.035 wire size

NOTE: If individual parts are required, see Parts List chapter of this manual for part number to order.

TRUE BLUE[®]

WARRANTY

Effective January 1, 2000

(Equipment with a serial number preface of "LA" or newer)

This limited warranty supersedes all previous Miller warranties and is exclusive with no other guarantees or warranties expressed or implied.

Warranty Questions?

Call
1-800-4-A-MILLER
for your local
Miller distributor.

Your distributor also gives
you ...

Service

You always get the fast,
reliable response you
need. Most replacement
parts can be in your
hands in 24 hours.

Support

Need fast answers to the
tough welding questions?
Contact your distributor.
The expertise of the
distributor and Miller is
there to help you, every
step of the way.

LIMITED WARRANTY – Subject to the terms and conditions below, Miller Electric Mfg. Co., Appleton, Wisconsin, warrants to its original retail purchaser that new Miller equipment sold after the effective date of this limited warranty is free of defects in material and workmanship at the time it is shipped by Miller. THIS WARRANTY IS EXPRESSLY IN LIEU OF ALL OTHER WARRANTIES, EXPRESS OR IMPLIED, INCLUDING THE WARRANTIES OF MERCHANTABILITY AND FITNESS.

Within the warranty periods listed below, Miller will repair or replace any warranted parts or components that fail due to such defects in material or workmanship. Miller must be notified in writing within thirty (30) days of such defect or failure, at which time Miller will provide instructions on the warranty claim procedures to be followed.

Miller shall honor warranty claims on warranted equipment listed below in the event of such a failure within the warranty time periods. All warranty time periods start on the date that the equipment was delivered to the original retail purchaser, or one year after the equipment is sent to a North American distributor or eighteen months after the equipment is sent to an International distributor.

1. 5 Years Parts – 3 Years Labor
 - * Original main power rectifiers
 - * Inverters (input and output rectifiers only)
2. 3 Years — Parts and Labor
 - * Transformer/Rectifier Power Sources
 - * Plasma Arc Cutting Power Sources
 - * Semi-Automatic and Automatic Wire Feeders
 - * Inverter Power Supplies
 - * Intelligit
 - * Engine Driven Welding Generators
(NOTE: Engines are warranted separately by the engine manufacturer.)
3. 1 Year — Parts and Labor
 - * DS-2 Wire Feeder
 - * Motor Driven Guns (w/exception of Spoolmate 185 & Spoolmate 250)
 - * Process Controllers
 - * Positioners and Controllers
 - * Automatic Motion Devices
 - * RFCS Foot Controls
 - * Induction Heating Power Sources
 - * Water Coolant Systems
 - * HF Units
 - * Grids
 - * Maxstar 140
 - * Spot Welders
 - * Load Banks
 - * Miller Cyclomatic Equipment
 - * Running Gear/Trailers
 - * Plasma Cutting Torches (except APT & SAF Models)
 - * Field Options
(NOTE: Field options are covered under True Blue[®] for the remaining warranty period of the product they are installed in, or for a minimum of one year — whichever is greater.)
4. 6 Months — Batteries
5. 90 Days — Parts
 - * MIG Guns/TIG Torches
 - * Induction Heating Coils and Blankets

- * APT, ZIPCUT & PLAZCUT Model Plasma Cutting Torches
- * Remote Controls
- * Accessory Kits
- * Replacement Parts (No labor)
- * Spoolmate 185 & Spoolmate 250
- * Canvas Covers

Miller's True Blue[®] Limited Warranty shall not apply to:

1. **Consumable components; such as contact tips, cutting nozzles, contactors, brushes, slip rings, relays or parts that fail due to normal wear.**
2. Items furnished by Miller, but manufactured by others, such as engines or trade accessories. These items are covered by the manufacturer's warranty, if any.
3. Equipment that has been modified by any party other than Miller, or equipment that has been improperly installed, improperly operated or misused based upon industry standards, or equipment which has not had reasonable and necessary maintenance, or equipment which has been used for operation outside of the specifications for the equipment.

MILLER PRODUCTS ARE INTENDED FOR PURCHASE AND USE BY COMMERCIAL/INDUSTRIAL USERS AND PERSONS TRAINED AND EXPERIENCED IN THE USE AND MAINTENANCE OF WELDING EQUIPMENT.

In the event of a warranty claim covered by this warranty, the exclusive remedies shall be, at Miller's option: (1) repair; or (2) replacement; or, where authorized in writing by Miller in appropriate cases, (3) the reasonable cost of repair or replacement at an authorized Miller service station; or (4) payment of or credit for the purchase price (less reasonable depreciation based upon actual use) upon return of the goods at customer's risk and expense. Miller's option of repair or replacement will be F.O.B., Factory at Appleton, Wisconsin, or F.O.B. at a Miller authorized service facility as determined by Miller. Therefore no compensation or reimbursement for transportation costs of any kind will be allowed.

TO THE EXTENT PERMITTED BY LAW, THE REMEDIES PROVIDED HEREIN ARE THE SOLE AND EXCLUSIVE REMEDIES. IN NO EVENT SHALL MILLER BE LIABLE FOR DIRECT, INDIRECT, SPECIAL, INCIDENTAL OR CONSEQUENTIAL DAMAGES (INCLUDING LOSS OF PROFIT), WHETHER BASED ON CONTRACT, TORT OR ANY OTHER LEGAL THEORY.

ANY EXPRESS WARRANTY NOT PROVIDED HEREIN AND ANY IMPLIED WARRANTY, GUARANTY OR REPRESENTATION AS TO PERFORMANCE, AND ANY REMEDY FOR BREACH OF CONTRACT TORT OR ANY OTHER LEGAL THEORY WHICH, BUT FOR THIS PROVISION, MIGHT ARISE BY IMPLICATION, OPERATION OF LAW, CUSTOM OF TRADE OR COURSE OF DEALING, INCLUDING ANY IMPLIED WARRANTY OF MERCHANTABILITY OR FITNESS FOR PARTICULAR PURPOSE, WITH RESPECT TO ANY AND ALL EQUIPMENT FURNISHED BY MILLER IS EXCLUDED AND DISCLAIMED BY MILLER.

Some states in the U.S.A. do not allow limitations of how long an implied warranty lasts, or the exclusion of incidental, indirect, special or consequential damages, so the above limitation or exclusion may not apply to you. This warranty provides specific legal rights, and other rights may be available, but may vary from state to state.

In Canada, legislation in some provinces provides for certain additional warranties or remedies other than as stated herein, and to the extent that they may not be waived, the limitations and exclusions set out above may not apply. This Limited Warranty provides specific legal rights, and other rights may be available, but may vary from province to province.





Owner's Record

Please complete and retain with your personal records.

Model Name	Serial/Style Number
Purchase Date	(Date which equipment was delivered to original customer.)
Distributor	
Address	
City	
State	Zip



For Service

Call 1-800-4-A-Miller or see our website at www.MillerWelds.com to locate a DISTRIBUTOR or SERVICE AGENCY near you.

Always provide Model Name and Serial/Style Number.

Contact your Distributor for:

- Welding Supplies and Consumables
- Options and Accessories
- Personal Safety Equipment
- Service and Repair
- Replacement Parts
- Training (Schools, Videos, Books)
- Technical Manuals (Servicing Information and Parts)
- Circuit Diagrams
- Welding Process Handbooks

Contact the Delivering Carrier for:

File a claim for loss or damage during shipment.

For assistance in filing or settling claims, contact your distributor and/or equipment manufacturer's Transportation Department.

Miller Electric Mfg. Co.

An Illinois Tool Works Company
1635 West Spencer Street
Appleton, WI 54914 USA

International Headquarters—USA

USA Phone: 920-735-4505 Auto-Attended
USA & Canada FAX: 920-735-4134
International FAX: 920-735-4125

European Headquarters – United Kingdom

Phone: 44 (0) 1204-593493
FAX: 44 (0) 1204-598066

www.MillerWelds.com

